



**SEAWARD**

GMC-INSTRUMENTS GROUP

# PV:1525 & PV:1525-IV

## USER MANUAL



[seaward.com](http://seaward.com)

TESTED. TRUSTED... WORLDWIDE

---

## Table of Contents

<b>1. Safety Instructions</b>	<b>4</b>
<b>2. Application</b>	<b>7</b>
2.1 Intended Use / Use for Intended Purpose	7
2.2 Use for Other than Intended Purpose	7
2.3 Liability and Guarantee	7
<b>3. Documentation</b>	<b>8</b>
3.1 Information Concerning these Instructions	8
3.2 Identification of Warnings	8
3.3 Identifiers	9
3.4 Symbols in the Documentation	9
<b>4. Getting Started</b>	<b>10</b>
<b>5. The Instrument</b>	<b>11</b>
5.1 Scope of Delivery	11
5.2 Instrument Overview	12
5.2.1 Front	12
5.2.2 Top Panel	12
5.3 Symbols on the Instrument and the Included Accessories	13
5.4 Included Features	14
5.5 Relevant Standards	15
5.6 Technical Specification	16
<b>6. Power Supply</b>	<b>20</b>
6.1 Powering ON / OFF	20
6.2 Battery Charging	20
<b>7. Operation</b>	<b>21</b>
7.1 Main Menu	21
7.1.1 Information Bar Symbols	22
7.1.2 Function Button Symbols	22
7.1.3 Directional Button Symbols	23
7.2 LED Illuminated Function Buttons	23
<b>8. Configuration</b>	<b>24</b>
8.1 General Settings	24
8.2 Connectivity Settings	24
8.2.1 Pairing with SS:200LR Wireless Irradiance Meter	25
8.2.2 Pairing with PV:1500 Clamp	26
<b>9. Measurements/Tests</b>	<b>27</b>
9.1 Switching the PV Installation ON / OFF	27
9.2 Operating Mode “Auto Test Sequence Mode”	28
9.2.1 Selecting and Performing Auto Test Sequences	29
9.2.2 Save test reference	29
9.2.3 String Test / IV Curve Measurement	30

9.2.4	DC Power (Measurement via PV:1500 Clamp) .....	32
9.2.5	Continuity.....	34
9.3	Operating Mode “Manual Mode” .....	36
9.3.1	Selecting and configuring a manual test.....	36
9.3.2	Performing a manual test .....	36
9.3.3	Insulation Resistance Measurement – R <sub>ISO</sub> (Point to Point) .....	37
9.3.4	Panel Voltage.....	39
9.3.5	Continuity.....	40
9.3.6	Current Clamp (Measurement via PV:1500 Clamp) .....	41
9.4	Downloading Test Results.....	42
9.5	Using the SolarCert PV Reporting Software .....	43
<b>10.</b>	<b>Storage and Transport.....</b>	<b>44</b>
<b>11.</b>	<b>Internal Instrument Log.....</b>	<b>44</b>
<b>12.</b>	<b>Maintenance .....</b>	<b>45</b>
12.1	Cleaning.....	45
12.2	Calibration .....	45
12.3	Firmware .....	46
12.3.1	View firmware version.....	46
12.3.2	Update your firmware.....	46
<b>13.</b>	<b>Troubleshooting .....</b>	<b>47</b>
<b>14.</b>	<b>Repair .....</b>	<b>52</b>
<b>15.</b>	<b>Service and Contact .....</b>	<b>53</b>
<b>16.</b>	<b>Certifications.....</b>	<b>54</b>
16.1	CE Declaration .....	54
16.2	UKCA marking .....	54
16.3	Calibration Statement and Certificate.....	54
<b>17.</b>	<b>Disposal and Environmental Protection .....</b>	<b>55</b>
17.1	Disposal of Old Devices, Batteries and Rechargeable Batteries .....	55
17.2	Disposal of Packaging Materials.....	55
17.3	Regulations for the Federal Republic of Germany .....	56
<b>Appendix A:</b>	<b>Internal Log Information .....</b>	<b>57</b>

---

## 1. Safety Instructions

	<p>Read and follow these instructions carefully and completely in order to ensure safe and proper use.</p> <p>The instructions must be made available to all persons who use the instrument.</p> <p>Keep for future reference.</p>
---	--

### General

- The instrument may only be used by adequately trained and qualified personnel in the commercial trades. It is not a consumer product.
- Observe and comply with all safety regulations which are applicable for your work environment.
- Wear suitable and appropriate personal protective equipment (PPE) whenever working with the instrument.
- The functioning of active medical devices (for example pacemakers, defibrillators) and passive medical devices may be affected by voltages, currents and electromagnetic fields generated by the instrument and the health of their users may be impaired. Implement corresponding protective measures in consultation with the manufacturer of the medical device and your physician. If any potential risk cannot be ruled out, do not use the instrument.

### Accessories

- Use only the specified accessories (included in the scope of delivery or listed as optional accessories) with the instrument.
- Carefully and completely read and adhere to the product documentation for optional accessories. Retain these documents for future reference.

### Handling

- Use the instrument in undamaged condition only. Inspect the instrument before use. Pay particular attention to damage, interrupted insulation or kinked cables.
- Use the accessories and all cables in undamaged condition only. Inspect accessories and all cables before use. Pay particular attention to damage, interrupted insulation or kinked cables.
- If the instrument or its accessories don't function flawlessly, permanently remove the instrument/accessories from operation and secure them against inadvertent use.
- If the instrument or accessories are damaged during use, for example if they're dropped, permanently remove the instrument/accessories from operation and secure them against inadvertent use.
- If there are any signs of interior damage to the instrument or accessories (e.g. loose parts in the housing), permanently remove the instrument/accessories from operation and secure them against inadvertent use.
- The instrument and the accessories may only be used for the tests/measurements described in the documentation for the instrument.
- The instruments and accessories of Seaward Electronic Ltd are designed to ensure optimum compatibility with the [Seaward Electronic Ltd products that are expressly provided for them. Unless otherwise expressly confirmed in writing by Seaward Electronic Ltd, they are neither intended nor suited for use with other products.
- Route cables in an orderly fashion, e.g. the mains power cable and accessories cable. Loose, disorderly cables result in unnecessary danger of tripping and falling.

---

## Measurements / Tests

- Please note that the voltage measurement function is subject to regional requirements, e.g.
  - European Union:  
The voltage measuring function and/or mains check integrated into the instrument may not be used to test systems or system components for the absence of voltage.  
Testing for the absence of voltage is only permissible with a suitable (2-pole) voltage tester or voltage measuring system which fulfills the requirements specified in EN 61243.
  - United Kingdom and rest of world:  
If the instrument is used to determine the presence or absence of dangerous voltages, the function of the voltage measurement unit must always be checked with a known voltage source or test unit before and after use.

## Operating Conditions

- Do not use the instrument and its accessories after long periods of storage under unfavorable conditions (e.g. humidity, dust or extreme temperature).
- Do not use the instrument and its accessories after extraordinary stressing due to transport.
- Only use the instrument and its accessories within the limits of the specified technical data and conditions (ambient conditions, IP protection code, measuring category etc.).
- Do not use the instrument in potentially explosive atmospheres. Danger of explosion!
- Do not use the instrument in areas subject to the risk of fire. Danger of fire!
- Implement adequate measures for protection against electrostatic discharge (ESD).

## Rechargeable or Regular Batteries

- Only use the rechargeable battery pack supplied with the instrument or listed as replacement part.
- Use (rechargeable) batteries in undamaged condition only. Risk of explosion and fire in the case of damaged (rechargeable) batteries!  
Inspect the (rechargeable) batteries before use. Pay particular attention to leaky and damaged (rechargeable) batteries.
- When using (rechargeable) batteries, the respective test/measuring instrument may only be used with inserted and secured battery compartment lid. Otherwise, dangerous voltages may occur at the battery terminals under certain circumstances.
- Only charge undamaged rechargeable batteries. Risk of explosion and fire in the case of damaged rechargeable batteries!  
Inspect the rechargeable batteries before charge. Pay particular attention to leaky and damaged rechargeable batteries.

## Measurement Cables and Establishing Contact

- Plugging in the measurement cables must not necessitate any undue force.
- Never touch conductive ends (e.g. of test probes).
- Avoid short circuits due to incorrectly connected measurement cables.
- Ensure appropriate contacting (e.g. on the test probes, crocodile clips, Kelvin probes, etc.).
- Do not move or remove contacts (e.g. the test probes, alligator clips, Kelvin probes etc.) until testing/measurement has been completed. This may result in electrical arcing and cause injury or damage to the installation and or the instrument.

## Calibration

- Comply with national calibration regulations and laws.
- Calibration may only be carried out by authorized service centers.

## Emissions

- The device is equipped with a Bluetooth® module. Determine whether or not use of the implemented frequency band of 2400 to 2483.5 MHz is permissible in your country.

---

## Data Security

- Always create a backup copy of your measurement/test data.
- The instrument is equipped with a data memory to which personal and/or sensitive data can be stored. Observe and comply with the applicable national data protection regulations. Use the corresponding functions provided by the instrument (such as access protection), as well as other appropriate measures to prevent unauthorized access to the data.

---

## 2. Application

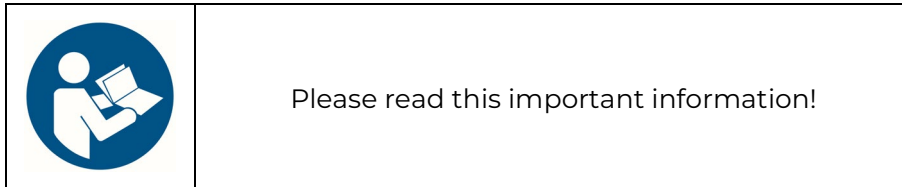

### 2.1 Intended Use / Use for Intended Purpose

The PV:1525 and PV:1525-IV, hereinafter referred to as instrument, are solar PV testers designed for the purpose of performing electrical safety testing and performance measures of photovoltaic systems up to 1500 V<sub>DC</sub> and 25 A (residential and commercial level installations).

The instruments differ in their range of functions, see 5.4 Included Features on page 14.

Application guidance:

- Residential and commercial systems up to 1000 V
- Utility-scale systems up to 1500 V  
(In higher current systems with higher irradiance values protection circuitry might be triggered due to effects of in-rush currents.)

Safety of the user, as well as that of the instrument, is only assured when it is used for its intended purpose.

### 2.2 Use for Other than Intended Purpose

Using the instrument for any purposes other than those described in the condensed operating instructions or these instrument operating instructions is contrary to use for intended purpose. Use for purposes other than those intended may result in unforeseeable damage!

### 2.3 Liability and Guarantee

The warranty provided by Seaward Electronic Ltd, and its liability, are governed by the applicable contractual and mandatory statutory provisions.

Register your instrument now

To activate your 2-year warranty please register your product at [seaward.com/register](https://seaward.com/register)

---

## 3. Documentation

### 3.1 Information Concerning these Instructions

Read these instructions carefully and attentively. They contain all necessary information for safe use of the instrument. Comply with these instructions in order to protect yourself and others from injury, and to avoid damaging the instrument.

The latest version of these instructions is available on our website:

<https://www.seaward.com/gb/support/>

#### Descriptions of Instruments Variants

This documentation describes several instrument variants. As a result, features and functions may be described which do not apply to your instrument. Furthermore, illustrations may differ from your instrument.

#### Errors and Suggestions for Improvement

These instructions have been prepared with utmost care in order to ensure correctness and completeness. Unfortunately, errors can never be entirely avoided. Continuous improvement is part of our quality goal, so we always appreciate your comments and suggestions.

#### Trademark Law

Product designations used in this document may be subject to brand law and patent law. They are the property of their respective owner.

#### Copyright

All rights reserved.

Nothing from this edition may be multiplied, or made public in any form or manner, either electronically, mechanically, by photocopying, recording, or in any manner, without prior written consent from Seaward Electronic Ltd. This also applies to accompanying drawings and diagrams.

Due to a policy of continuous development Seaward Electronic Ltd reserves the right to alter the equipment specification and description outlined in this publication without prior notice and no part of this publication shall be deemed to be part of any contract for the equipment unless specifically referred to as an inclusion within such contract.

### 3.2 Identification of Warnings

Instructions for your safety and for the protection of the instrument and its environment are provided as warnings and notes at certain points within these instructions.

They're laid out as shown below and are graded in terms of the severity of the respective hazard. They also describe the nature and cause of the hazard, the consequences of non-observance and what must be done to avoid it.



#### **DANGER**

Death or serious injury is almost certain.



#### **WARNING**

Death or serious injury is possible.



#### **CAUTION**

Minor or moderate injury possible.



## ATTENTION

Damage to the product or the environment.



### Note

Important information.



### Tip

Useful additional information or application tip.

## 3.3 Identifiers

The following identifiers are used in this documentation:

Identifier	Meaning
<b>Control element</b>	Keys, buttons, menus and other controls
✓ Prerequisite	A condition etc. which must be fulfilled before a given action can be taken
1. Procedural step	Steps of a procedure which must be completed in the specified order
↳ Result	Result of a procedural step
■ Enumeration □ Enumeration	Bullet lists
Footnote	Comment

## 3.4 Symbols in the Documentation

The following icons are used in this documentation:

Icon	Meaning
	Read and adhere to the product documentation.
	General warning symbol.
	Warning regarding electrical voltage.

---

## 4. Getting Started

This chapter gives you an overview of the initial steps with the instrument.

1. Read and adhere to the product documentation. In particular, observe all safety information in the documentation, on the instrument and on the packaging.
  - Safety Instructions, see page 4.
  - Application, see page 7.
  - Documentation, see page 8.
2. Familiarize yourself with the instrument, see page 11.
3. Familiarize yourself with the instrument's operation, see page 21.
4. Configure the instrument, see page 24.
5. Perform measurements/tests, see page 27.

Further topics of interest: Maintenance, see page 44.

---

## 5. The Instrument

### 5.1 Scope of Delivery

All instruments of the PV:1525 series are available as basic instrument or as extended kits differing in accessories. The scope of supply depends on your choice of model and equipment scope.

	Instrument Only	Complete Kit
Instrument (PV:1525 or PV:1525-IV)	✓	✓
4mm test probes with Alligator Clips	✓	✓
Instrument to MC4 Test Leads	✓	✓
Rechargeable battery pack	✓	✓
Battery charging cradle	✓	✓
PV:1500 Clamp*	x	✓
SS:200LR Irradiance Meter*	x	✓
Solar Survey – Quick release panel mounting bracket	x	✓
Carry Case	✓	✓
Quick Start Guide	✓	✓
Declaration of conformity	✓	✓
Calibration certificate	✓	✓
SolarCert software license (1 x)	x	✓

\*Complete product. Full scope of delivery see PV:1500 Clamp Manual and Quick Start Guide SS:200LR Wireless Irradiance Meter.

### Optional Accessories

Some measurements necessitate optional accessories:

Bypass measurement leads

Part Number: 601A1201

Information on replacement parts can be found in the instrument's data sheet.

---

## 5.2 Instrument Overview

### 5.2.1 Front



- 1 3.5" Color screen display
- 2 Function button 1 (illumination color changes dependent on function, see page 21)
- 3 Function button 2 (illumination color changes dependent on function, see page 21)
- 4 Directional keypad
- 5 Power button





### 5.2.2 Top Panel



- 6 Negative (-) PV test lead input and negative (-) continuity lead input (black)
- 7 Positive (+) PV test lead input and positive (+) continuity lead input (yellow)
- 8 Insulation lead output (red)

---

### 5.3 Symbols on the Instrument and the Included Accessories

Icon	Meaning
	Warning concerning a point of danger (attention, observe documentation!)
	The instrument may not be disposed of with household trash
	Warning regarding dangerous electrical voltage
	European conformity marking
	UK conformity marking

## 5.4 Included Features

Feature	PV:1525	PV:1525-IV
Auto test sequences – Efficient standard-compliant electrical safety testing according to DIN EN 62446-1 / VDE 0126-23-1 with 3 preprogrammed sequences	✓	✓
Auto test sequences – Customizable sequences for individual testing	✓	✓
Manual mode for diagnostic testing	✓	✓
Open-circuit voltage and voltage measurement	✓	✓
Short-circuit current measurement	✓	✓
String test	✓	✓
Earth continuity / resistance measurement	✓	✓
Insulation resistance measurement	✓	✓
Operating power (with PV:1500 Clamp)	✓	✓
Graphical IV curve trace with display directly on screen	x	✓
Calculation of maximum power point voltage, maximum power point current, and fill factor	x	✓
Standard test condition (STC) comparison according to DIN EN IEC 60904-9 / VDE 0126-4-9* (via PV:Sync Mobile app and SolarCert software)	✓	✓
Bluetooth® data transfer to PV:Sync Mobile App	✓	✓

\* For accurate comparison, irradiance and temperature data via the SS:200LR Wireless Irradiance Meter are required.

---

## 5.5 Relevant Standards

The instrument has been manufactured and tested in accordance with the following safety regulations:

IEC 60529	Degrees of protection provided by enclosures (IP code)
IEC 61010-1	Safety requirements for electrical equipment for measurement, control and laboratory use – Part 1: General requirements
IEC 61010-2-034	Safety requirements for electrical equipment for measurement, control, and laboratory use – Part 2-034: Particular requirements for measurement equipment for insulation resistance and test equipment for electric strength
IEC 61326-1	Electrical equipment for measurement, control and laboratory use – EMC requirements – Part 1: General requirements
IEC 61557-1	Electrical safety in low voltage distribution systems up to 1 000 V AC and 1500 V DC – Equipment for testing, measuring or monitoring of protective measures – Part 1: General requirements
IEC 61557-2	Electrical safety in low voltage distribution systems up to 1 000 V AC and 1500 V DC – Equipment for testing, measuring or monitoring of protective measures – Part 2: Insulation resistance
IEC 61557-4	Electrical safety in low voltage distribution systems up to 1000 V AC and 1500 V DC – Equipment for testing, measuring or monitoring of protective measures – Part 4: Resistance of earth connection and equipotential bonding
IEC 61557-10	Electrical safety in low voltage distribution systems up to 1000 V AC and 1500 V DC – Equipment for testing, measuring or monitoring of protective measures – Part 10: Combined measuring equipment for testing, measuring and monitoring of protective measures.

## 5.6 Technical Specification

### Open Circuit Voltage and Voltage Measurement (PV Terminals)

Display range	+10.0 V <sub>DC</sub> ... +1500 V <sub>DC</sub> -10.0 V <sub>DC</sub> ... -440 V <sub>DC</sub> 10.0 V <sub>AC</sub> ... 440 V <sub>AC</sub>
Measuring range	+10.0 V <sub>DC</sub> ... +1500 V <sub>DC</sub> -10.0 V <sub>DC</sub> ... -440 V <sub>DC</sub> 10.0 V <sub>AC</sub> ... 440 V <sub>AC</sub>
Resolution	0.1 V <sub>DC</sub> maximum
Accuracy	for +DC: ± (0.5 % + 2 digits) for -DC and AC: ± (5 % + 2 digits)

### Short Circuit Current Measurement (PV Terminals)

Display range	0.00 A <sub>DC</sub> ... 25.00 A <sub>DC</sub>
Measuring range	0.50 A <sub>DC</sub> ... 25.00 A <sub>DC</sub>
Maximum power	37.5 kW
Resolution	0.1 A <sub>DC</sub> maximum
Accuracy	± (1 % + 2 digits)

### Maximum Power

Maximum power rating	37.5 kW* at panel efficiency ≤ 19 % 25 kW* at panel efficiency > 19 %
Voltage	up to 1500 V <sub>DC</sub>
Current	up to 25 A <sub>DC</sub>

### IV Curve (PV:1525-IV only)

Minimum number of test points	20
IV curve maximum power rating	37.5 kW* at panel efficiency ≤ 19 % 20 kW* at panel efficiency > 19 %
Voltage	up to 1500 V <sub>DC</sub>
Current	up to 25 A <sub>DC</sub>

\* Power limit is dynamically adjusted to compensate for in-rush currents due to various factors including (but not limited to) module efficiency, parasitic effects caused by the installation, and environmental factors such as irradiance.



## Earth Continuity / Resistance Measurement

Test voltage open circuit	$> 4 V_{DC}$ , nominal
Test current into 2 $\Omega$	$> 200$ mA
Display range	0.00 $\Omega$ ... 199 $\Omega$
Measuring range (IEC 61557-4)	0.05 $\Omega$ ... 199 $\Omega$
Resolution	0.01 $\Omega$ maximum
Accuracy	0.05 $\Omega$ ... 0.09 $\Omega$ $\pm$ (2 % +1 digit) 0.10 $\Omega$ ... 0.19 $\Omega$ $\pm$ (2 % +2 digits) 0.20 $\Omega$ ... 1.99 $\Omega$ $\pm$ (2 % +3 digits) 2.0 $\Omega$ ... 4.9 $\Omega$ $\pm$ (2 % +2 digits) 5.0 $\Omega$ ... 199 $\Omega$ $\pm$ (2 % +5 digits)
Test leads zero	Zero up to 10 $\Omega$
Visible warning	$\geq 30 V_{AC}$ or $V_{DC}$ at inputs
Circuitry protection	Test inhibited if $\geq 30 V_{AC}$ or $V_{DC}$ at inputs
Repeat tests as per IEC 61557-4	Approx. 4000 1-second tests

## Insulation Resistance Measurement

Test voltage open circuit	250 V, 500 V, 1000 V, 1500 V (as per IEC 61557-2)
Test voltage specification	-0 % +20 % (open circuit)
Test current short circuit	$< 2$ mA
Test voltage @ 1 mA	$> 1$ mA into $U_n \times (1000 \Omega/V)$ (as per IEC 61557-2)
Display range	0.05 M $\Omega$ ... 999 M $\Omega$
Measuring range (IEC 61557-2)	250 V/500 V String Mode: 0.05 M $\Omega$ ... 200 M $\Omega$ 1 kV/1.5 kV String Mode: 0.05 M $\Omega$ ... 999 M $\Omega$ 250 V Point to Point: 0.05 M $\Omega$ ... 300 M $\Omega$ 500 V Point to Point: 0.05 M $\Omega$ ... 500 M $\Omega$ 1 kV/1.5 kV Point to Point: 0.05 M $\Omega$ ... .999 M $\Omega$
Resistance Resolution	0.01 M $\Omega$ for 0.05 M $\Omega$ ... 1.99 M $\Omega$ 0.1 M $\Omega$ for 2.0 M $\Omega$ ... 19.9 M $\Omega$ 1 M $\Omega$ for 20 M $\Omega$ ... 999 M $\Omega$
Resistance Accuracy	$\pm$ (5 % + 1 digit) for 0.05 M $\Omega$ ... 0.19 M $\Omega$ $\pm$ (5 % + 3 digits) for 0.20 M $\Omega$ ... 1.99 M $\Omega$ $\pm$ (5 % + 2 digits) for 2.0 M $\Omega$ ... 5.0 M $\Omega$

	±(5 % + 5 digits) for 5.1 MΩ ... 99 MΩ ±(10 % + 5 digits) for > 99 MΩ
Insulation voltage resolution	1 V
Insulation voltage accuracy	± (2 % + 2 counts)
Maximum system capacitance	2 μF
Visible warning	≥ 30 V <sub>AC</sub> or V <sub>DC</sub> at inputs
Repeat tests as per IEC 61557-2	Approx. 4000 1-second tests

#### Operating Current (Wireless via PV:1500 Clamp)

Display range	0.1 A <sub>DC</sub> ... 400.0 A <sub>DC</sub>
Current measuring range	0.1 A <sub>DC</sub> ... 400.0 A <sub>DC</sub>
Resolution	0.1 A
Accuracy	± (2 % + 5 digits)

#### Operating Power (PV Terminals & wireless via PV:1500 Clamp)

Display range	0.00 kW ... 600 kW
Measuring range	0.50 kW ... 600 kW
Resolution	0.01 kW
Accuracy	± (6 % + 2 digits)

#### Mechanical Design

Weight	Approx. 1 kg / 2.2 lb
Dimensions	265 mm × 115 mm × 78 mm / 10.4" × 4.6" × 3.1"
Display type	3.5" color display with backlight
Display resolution	480 × 320 pixels
Display FOV	70° left to right 60° top to bottom
Power source	11.55 V 2930 mAH lithium ion battery (rechargeable)
Auto power down	User-configurable
Onboard memory	1000 slots

## Environmental Conditions

Environment	Dry, without moisture condensation indoor or outdoor use
Operating temperature	+5 °C ... +40 °C / +41 °F ... +104 °F
Storage	-25 °C ... +65 °C / -13 °F ... +149 °F Dry, without moisture condensation; without battery pack
Barometric elevation	Max. 2000 m / 6562 ft.

## Electrical Safety

Overvoltage category	IEC 61010-01 CAT III / 1500 V (Measurement Category III is applicable to test and measurement circuits connected to the distribution part of the buildings low-voltage mains installation, this includes distribution boards, circuit breakers and wiring.)
Pollution degree	2 (as per IEC 61010-1)
Protective system	Housing: IP40 as per IEC 60529 (Protection against ingress of solid foreign objects: $\geq 1.0$ mm / 0.039" $\varnothing$ ; protection against ingress of water: not protected)
Protection category	II

## Electromagnetic Compatibility (EMC)

Interference emission	IEC 61326-1, class A
Interference immunity	IEC 61326-1

## Data Interfaces

<b>Bluetooth® LE</b>	
Frequency band(s)	2402 MHz ... 2480 MHz
Transmit power range(s)	20 dBm
Modulation type(s)	GFSK
Channel spacing(s)	2 MHz
Radio spectrum efficiency (Art. 3.2)	ETSI EN 300 328 V2.2.2
Antenna type and gain	PCB antenna, 3.26 dBi
Usage	Transfer of test data; connection to peripherals, software updates

<b>Long-Range RF</b>	
Frequency band(s)	433.375 MHz ... 434.625 MHz
Transmit power range(s)	4.89 dBm ERP
Modulation type(s)	CSS
Channel spacing(s)	250 kHz
Radio spectrum efficiency (Art. 3.2)	ETSI EN 300 220-2 V3.2.1
Antenna type and gain	FPC antenna, 2.8 dBi peak gain
Usage	Connect to SS200:LR Wireless Irradiance Meter

## 6. Power Supply

### 6.1 Powering ON / OFF

1. Press the power button for 2 seconds.
  - ↳ The display becomes active/inactive.

### 6.2 Battery Charging

The instrument comes with a battery charging cradle to enable the battery to be recharged. The charging cradle uses a USB-C connection, so it can be used with a wall charger or even on the go in a vehicle.

To charge the battery, ensure the cradle has been supplied with power via the USB-C socket and place the battery into the cradle, ensuring the charging sockets of the battery mate with the charging pins of the cradle.

Red and green LEDs will indicate various stages of the charging cycle.

<b>LED Illuminated Buttons</b>	<b>Function</b>
Alternating flashing red and green	The cradle has power, but no battery is connected.
Flashing red	The unit is charging the battery, current charge level less than 33 %.
Flashing red and green together	The unit is charging the battery, current charge level between 33 % and less than 66 %.
Flashing green	The unit is charging the battery, current charge level between 66 % and 100 %
Solid green	The battery is fully charged.

## 7. Operation



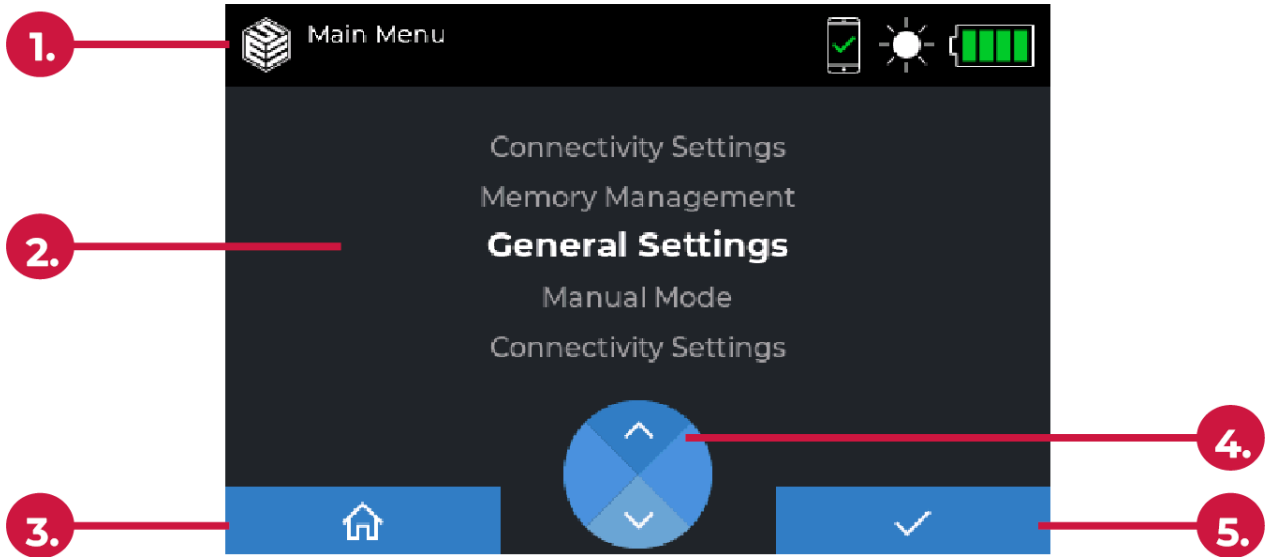

### 7.1 Main Menu



Display element	Function
1. Information bar	This area provides information about the status of the instrument and its peripherals. This will always include the currently selected screen and status of battery and connected devices. In addition, if hazardous voltages are present, this will be indicated by a yellow bar with a warning triangle.
2. Main area	This area is used to display menu items, text fields or test information.
3. Function key 1	This section shows the current function of the F1 key. This will vary from screen to screen and is only present where the buttons have a function.
4. Directional keys	Allow simple navigation through on screen menus and displays. This will vary from screen to screen and is only present where the buttons have a function.
5. Function key 2	This section shows the current function of the F2 Key. This will vary from screen to screen and is only present where the buttons have a function.







### 7.1.1 Information Bar Symbols

The symbols on the information bar provide information about the status of the instrument and its peripherals. The instrument is equipped with the following display symbols:

Symbol	Function
	Indicates battery level, each section of the battery represents 25 % of the battery life remaining, any percentage over 50 % will show green, then yellow until 25 % and finally red when in the last quarter.
	Indicates that a Wireless Irradiance Meter (SS:200LR) is paired and connected to the Instrument.
	Indicates that the instrument is paired to a mobile device.
	Indicates that hazardous voltages might be present due to the nature of the test being performed, or the presence of voltage has been detected when making connections.







### 7.1.2 Function Button Symbols

The following symbols may be shown on either of the Function 1 or Function 2 buttons. They vary from screen to screen and are only present where the buttons have a function.

Symbol	Function
	<b>Home</b> – Pressing this symbol navigates back to the home screen.
	<b>Menu</b> – This symbol will open a menu screen.
	<b>Back</b> – Returns to the previous screen.
	<b>Accept</b> – Confirms the action.
	<b>Start Test</b> – This option begins a test or test sequence.
	<b>Save</b> – Used to save test details, including result.
	<b>About</b> – Gives detail on the hardware and firmware of the device.



### 7.1.3 Directional Button Symbols

The on-screen representation of the directional buttons show the functions available when pressing one of the four buttons. Only a directional arrow populated with a symbol will have a function.

Symbol	Function
	A traditional arrow will indicate when a cursor movement is possible, i.e. for entering data or navigating a menu. It may also indicate a page movement, e.g. a down arrow may represent a page down function, where extra options are available.
	The skip arrows allow you to jump to the top respectively bottom.
	Using the eye icon, you can switch from measured values to viewing the IV curve on screen. (PV:1525-IV only)
	From the home screen, numbered slots represent the stored auto test sequences. Ω (PV:1525-IV only): enters the continuity test menu
	Prior to beginning an insulation resistance test V+ will allow the user to cycle through the applied voltage between 250 V <sub>DC</sub> , 500 V <sub>DC</sub> , 1000 V <sub>DC</sub> and 1500 V <sub>DC</sub> .
	Deletes any marked items or results from the memory management menus.

### 7.2 LED Illuminated Function Buttons

The instrument has two smart function buttons that will illuminate in different colors depending on the functionality of the button as an action within the current screen.

Symbol	Function
	Blue illumination indicates that a button press will perform a function.
	Green illumination indicates that a button press will start a test.
	Red illumination indicates that a button press will abort a test.

---

## 8. Configuration

### 8.1 General Settings

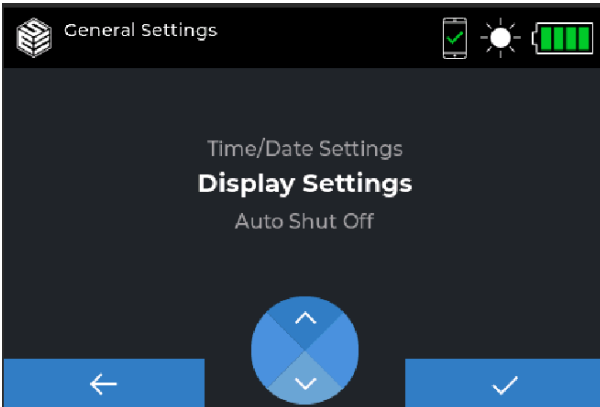

The general settings option allows for the main system settings to be changed. These include language, time and date settings and screen brightness with timeout and auto shut off time for battery savings.

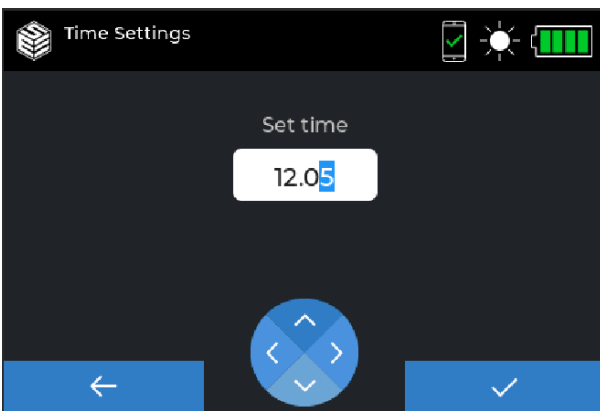

The date and time are factory set but can be manually changed. Alternatively, when connected to the PV:Sync Mobile app, the instrument will automatically sync with the instrument time.

### 8.2 Connectivity Settings

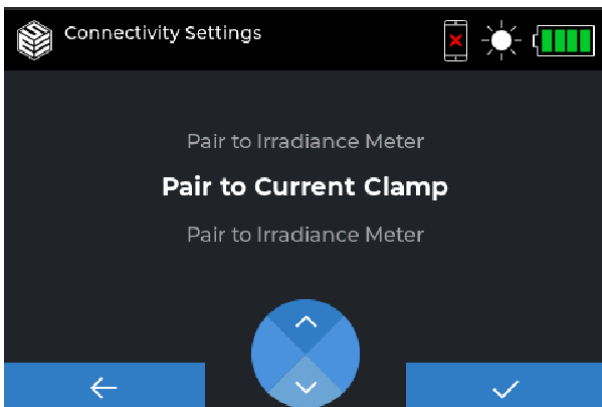

Connectivity settings allow for the pairing of the Wireless Irradiance Meter (SS:200LR) and the Current Clamp (PV:1500).

This chapter only describes the pairing of the Wireless Irradiance Meter (SS:200LR) and the Current Clamp (PV:1500). For more information on those devices, see their product documentation.



## 8.2.1 Pairing with SS:200LR Wireless Irradiance Meter

- ✓ You have read the SS:200LR documentation and set it up for use. See Quick Start Guide for SS:200LR Wireless Irradiance Meter.
- ✓ The instrument and SS:200LR to be paired are within a range of less than 150 m. Ideally, next to each other.
- ✓ Prevent interference during pairing: Have no other instrument and/or SS:200LR turned on anywhere within a 300 m radius.

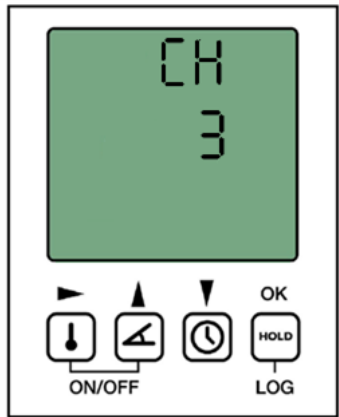

On the SS:200LR:

1. Connect the temperature sensor to the instrument.
2. Press and hold **ANGLE** and **CLOCK** for 2 s to enter the channel selection mode.
3. Select a channel ID between 0 and 5 and press **OK** to store the channel.
4. Note the channel you set.

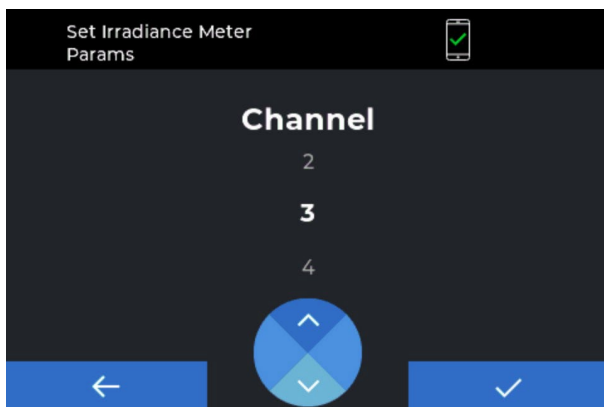

On the instrument:

1. Enter the **Main Menu** by pressing the **Menu** button.
2. Navigate to **Connectivity Settings** and press **Accept**.
3. Select **Pair to Irradiance Meter** and press **Accept**.
4. From the list **Channel**, select the channel you set on the SS:200LR.
5. Press **Accept** to save the selected channel.

6. Turn both instruments off and then back on to initiate communications.

↳ The instruments are paired.

Tests on the instrument can now be performed with data of irradiance and both ambient and panel temperature.



### Note

Prevent interference:  
Keep any other paired set of instruments away; if paired with a different channel for a distance 10 m, if paired on the same channel for a distance of 300 m.



### Note

The SS:200LR Wireless Irradiance Meter will automatically power off after

- 30 min of measured darkness
- 15 min from switch on with no initial pairing to the instrument and no button presses
- 12 hours after first switch on

Indication of connection status:



On the instrument:

Any test screen displays a sun in the upper right corner to indicate connection to a SS:200LR Wireless Irradiance Meter.

Live values for irradiance and both the ambient and panel temperature are displayed in a line on the test screen.

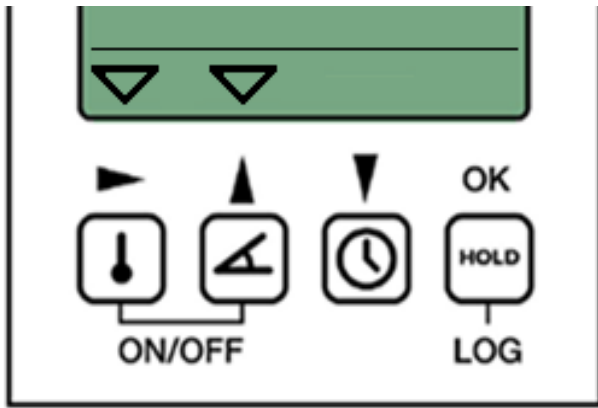

On the SS:200LR Wireless Irradiance Meter:

The triangles in the display indicate the connection status:

- paired = solid triangle above temperature button
- paired and transmitting = solid triangle above temperature button + simultaneously flashing triangle above the angle button
- (never paired = flashing triangle above temperature button – on for 2 s, then off for 10 s)

### 8.2.2 Pairing with PV:1500 Clamp

The instrument can be paired with the PV:1500 Clamp (via Bluetooth®) for power measurements.

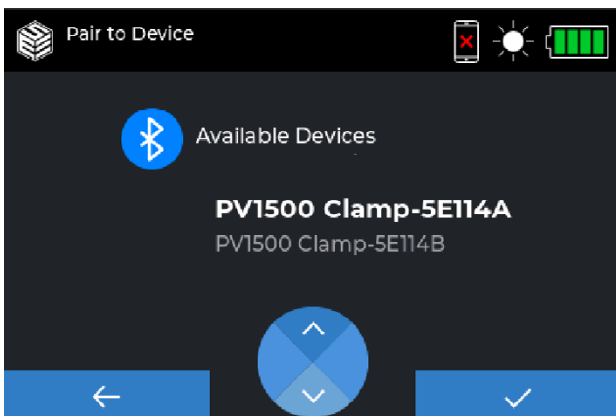

1. Enter **Main Menu** by pressing the **Menu** button.
2. Navigate to **Connectivity Settings** and press **Accept**.
3. Select **Pair to Current Clamp** and press **Accept**.
4. Select the required current clamp and press **Accept** to store the device.



#### Note

The number after PV:1500 is the current clamp's serial number, which can be located on the rear of the instrument and serves as a useful identifier.

---

## 9. Measurements/Tests



### WARNING

#### Risk of electrical shock

The instrument may apply high voltage or mains power to the appliance under test.

- The DC supply must be isolated from earth/ground during testing.
  - Do not touch the PV installation or any metal parts while tests are active.
  - Always ensure that the circuit under test is electrically isolated.
  - Do not leave the test instrument permanently connected to a PV installation. Always disconnect all test leads immediately after use.
  - The instrument is not intended for continuous use. When the instrument is not being used, disconnect it from the system under test.
  - Do not attempt to turn the instrument off while tests are active.
  - Do not test with optimizers connected.
  - Use test probes with alligator clips only.
  - Always ensure that the circuit under test is electrically isolated before attempting an earth resistance measurement or insulation measurement.
  - During insulation measurement, high voltages are present at the test tips. Use alligator clips to connect prior to testing.
- 

### 9.1 Switching the PV Installation ON / OFF

The PV installation cannot be turned off and is tested live.

The PV string or panel must be disconnected from the PV inverter during string tests, insulation tests, and continuity tests.

For power tests, the PV string or panel must be connected to the inverter.

### ATTENTION

#### Improper disconnection

Risk of a blown internal fuse and loss of functions if you do not disconnect the PV string/panel from the PV inverter properly. The fuse is not user-replaceable.

- During testing, always ensure that the PV string/panel is connected or disconnected properly.
-

---

## 9.2 Operating Mode “Auto Test Sequence Mode”

In this mode, the PV:1525 offers three different test sequences and the PV:1525-IV offers four different test sequences that can be configured and performed.

The following types of measurements are available within the test sequences:

String Test Measurement:

- $V_{O/C}$  – Open-circuit voltage
- $I_{S/C}$  – Short-circuit current
- $R_{ISO}$  – Insulation resistance

DC Power:

- $V_{O/C}$  – Open-circuit voltage
- $I_{CLAMP}$  – Current measurement via clamp
- Power – DC power calculation

Continuity Test:

- $V_{PE}$  – Protective earth voltage
- $R_{PE}$  – Protective earth resistance

IV Curve Trace:

- $V_{O/C}$  – Open-circuit voltage
- $I_{S/C}$  – Short-circuit current
- $R_{ISO}$  – Insulation resistance
- Curve Trace



### Note

For correct measurements, the SS:200LR Wireless Irradiance Meter needs to be connected as current and voltage are affected by irradiance and temperature.

---

The following symbols are present during a test sequence:



Indicates the test sequence is running



Indicates that a test, if accompanied by limits, has passed.



Indicates that a test, if accompanied by limits, has failed or has been aborted by the user by pressing the stop button.

## 9.2.1 Selecting and Performing Auto Test Sequences

For ease and simplicity of running auto test sequences, these are available to run directly from the home screen of the instrument.



Sequence selection available depends on the model (here: PV:1525-IV).

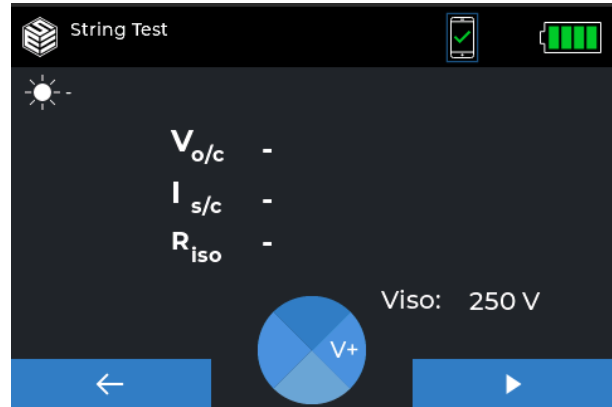

A typical sequence showing  $V_{o/c}$ ,  $I_{s/c}$  and the insulation resistance measurement.

1. Press the corresponding numbered button to select the desired sequence.  
(PV:1525-IV: press  $\Omega$  to select continuity test)
  - ↳ The instrument enters into the test mode for the selected sequences.
2. Press function button 2 (green illuminated) to start the test sequence.
  - ↳ The measured value will be displayed and the instrument will go on to the next test.
  - ↳ Once the sequence is complete, the results will be displayed on-screen for review.

When entering the Site and Inverter, the cursor is on **Save** by default, allowing immediate confirmation without additional navigation. For the String Number, the cursor automatically defaults to +1, enabling rapid incrementing of the string index.

## 9.2.2 Save test reference



The test data can be saved to memory by pressing the save function key.

There are three information fields in the resulting screen:

- Site location – Area in which testing is being performed, for example town, or name of plant.
- Test reference – Inverter or circuit reference for example.
- String number – or other reference.

Enter the reference data, for example circuit reference, and string number then press the save button once more. Results are now stored to memory and ready to be downloaded to the PV:Sync Mobile app.

The instruments can store a maximum of 1000 records (a record is described as any combination of tests taken as part of a sequence).

### 9.2.3 String Test / IV Curve Measurement



#### Note

If the instrument measures a current of greater than 25 A, it will NOT perform the insulation resistance ( $R_{ISO}$ ) test!

Instead, it will record the open circuit voltage and a value of >25 A for the string test. These values can be saved to memory, but the insulation resistance test ( $R_{ISO}$ ) will NOT be recorded.



#### Note

During automatic sequences where  $I_{SC}$  measurements are taken along with insulation resistance tests, the red insulation probe may be left in place for the entire sequence.

Setting the default test voltage for insulation resistance measurements. This allows the default voltage to be set to any of the standard test voltages performed by the instrument.

#### Connection



1. Connect the test leads:
  - Use black and yellow 4 mm to MC4 leads connected to the PV+ and the PV- terminals
  - Use red alligator clip and connect to earthing point or frame of the solar module
2. To perform a string test: From the main menu, press the left directional button and choose **String Test**.  
To perform an IV Curve Trace measurement (PV:1525-IV only): From the main menu, press the right directional button and choose **IV Curve**.

- 
- By pressing the right direction button, cycle through available test voltages 250 V / 500 V / 1000 V / 1500 V for insulation resistance, or choose **Skip** to omit the test.

**Note**

Once connected to the panel, the instrument will measure the open circuit voltage. If the instrument detects an AC voltage or a negative DC voltage, this will be displayed. Please note that the test sequence will be inhibited, and the start condition will not initiate the test.

---

- To initiate the test, press **Start**. A circular animation will indicate that the test is running. All results will be populated approximately three seconds after the start of the process.
  - Press **Save** to store records in internal memory. The instrument will prompt the user to enter 3 different fields:
    - Site Location
    - Inverter
    - String Number
- Use the directional buttons and the **Save** icon to add information to the field. Upon completion, proceed to the designated checkbox to advance to the subsequent field.
- The instrument will confirm that the results are written to memory.
  - Press function button 2 to navigate back to other applications.

**Note**

The instrument will inhibit the performance of another test for 5 seconds (indicated by the lack of a green illuminated start condition).

---

---

## 9.2.4 DC Power (Measurement via PV:1500 Clamp)

### Connection

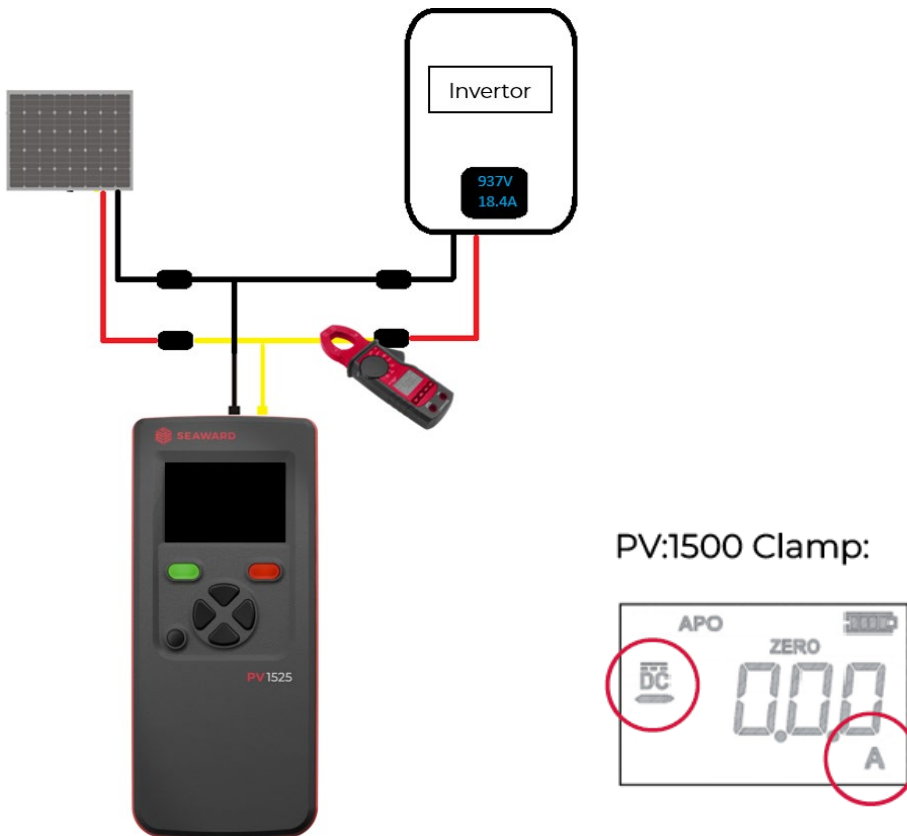

- ✓ The inverter is switched off or correctly isolated.
  - ✓ PV:1500 Clamp is connected to the instrument.
  - ✓ The Bypass measurement leads for power measurement (601A1201) is on hand for tapping into the connection between inverter and solar module(s).
1. Remove input cables from inverter.
  2. Connect the yellow test lead with the input cable and the inverter.
  3. Connect the black test lead with the input cable and the inverter.
  4. Connect the yellow and black MC4 leads with the instrument.
  5. Set the PV:1500 Clamp to **A AC/DC** and select the DC measurement mode (see product documentation).
  6. Press the corresponding directional button of the instrument to choose **DC Power (Current Clamp)**.
    - ↳ The instrument enters test mode for the selected test.
    - ↳ Status indicator shows **Connecting** and switches to **Connected**.
  7. Turn power to the inverter on.
    - ↳ The instrument displays measured values.
  8. Place the clamp meter around the yellow and black test lead.
    - ↳ Measured values of the black test lead are displayed on the instrument and clamp.
  9. Press function button 2 to save the measured values.



- 
10. Place the clamp meter around the yellow test lead.
    - ↳ Measured values of the yellow test lead are displayed on the instrument and PV:1500 Clamp.
  11. Press function button 2 to save the measured values.



### Note

This entire process is identical for manual mode, without the ability to save the result.



### Tip

For the most accurate reading ensure to zero-out the PV:1500 Clamp by pressing and holding the **SELECT / ZERO** button for two seconds until the **ZERO** icon is displayed above the reading.

---

## 9.2.5 Continuity

### Connection

#### Continuity Test – Test Lead Null

- ↳ Result must be 0.
- ↳ The result must not change.



#### Continuity Test – Continuity Measurement



### Connection

#### Protective Earth Resistance - $R_{PE}$ Voltage Measurement



1. From **Main Menu**, press the right directional button  
The continuity menu opens.

- 
2. Optional: Perform an offset compensation to remove any resistance associated with test leads and thus allow for more accurate continuity measurements. To do so, short the test leads together (see connection figure) and press the right direction arrow **Null**.
    - ↳ A circular animation indicates that the null function is in progress.
    - ↳ Test data is stored and the message **Null is set** is displayed.
  3. Press function button 2 (illuminated green).

The  $R_{PE}$  measurement starts.
  4. The measured  $R_{PE}$  result will be displayed.
  5. Press function button 2 to save test results. Predefined entries are Site location, Inverter number, and String number.
  6. Press function button 1 to confirm the save and return to the Continuity test screen.



### Note

If you want to remove the nulling after completing the measurement:

- Press the right directional button (Null) from the pre test screen.
  - ↳ The text Null is set will disappear indicating that the nulled value has been removed
-

---

## 9.3 Operating Mode “Manual Mode”

The instruments can also run all tests in manual mode. This can be useful where diagnostic checks are required. Tests performed in manual mode are not connected to memory and cannot be stored to memory for download to software. Manual mode can be accessed from the main menu.

The following tests are available in manual mode:

- Continuity
- Insulation resistance ( $R_{iso}$ ) – point to point
- Panel voltage
- Current clamp – using external current clamp PV:1500 Clamp
- Curve trace – IV curve (PV:1525-IV only)

### 9.3.1 Selecting and configuring a manual test

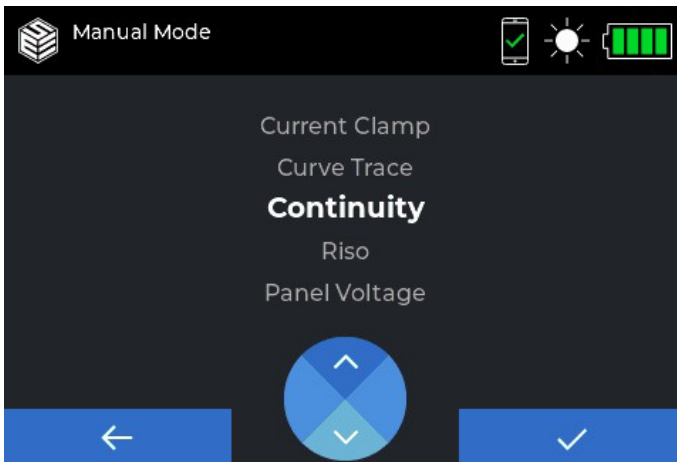

1. Press the **Menu** button.
  - ↳ Main menu opens.
2. Select **Manual Mode**.
  - ↳ All available test options are displayed.
3. Use the **directional button** to select the required test.
4. Press **Accept** to enter test mode.

The left / right directional arrows will display any available optional parameter changes, such as insulation test voltage, prior to the start of the test.

If connected to a SS:200LR Wireless Irradiance Meter, the irradiance will be constantly displayed in the top left-hand corner of the main test area.

Pressing the **Back** button will return you to the manual test list.

### 9.3.2 Performing a manual test

1. Press **Start test** button.
  - ↳ Test starts. Animation indicates that the test is in progress.
  - ↳ Measured values are displayed on screen and held until further action is taken, i.e. changing tests, or moving away from the screen.

---

### 9.3.3 Insulation Resistance Measurement – $R_{ISO}$ (Point to Point)

#### Connection

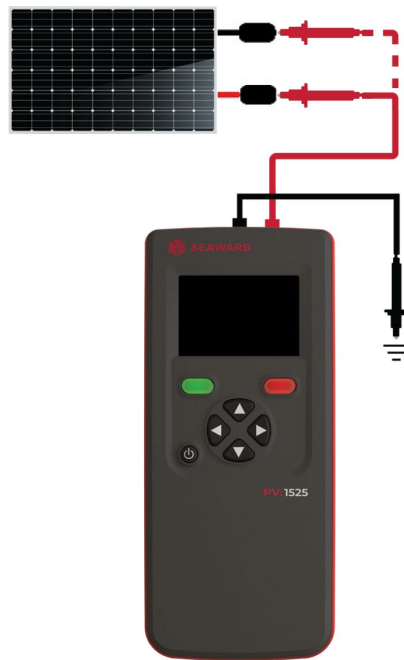

The insulation resistance measurement allows the user to measure the insulation between two points, using the red and black terminals. Voltage is applied from the red terminal and returns via the black terminal.

The test voltage can be set to perform the insulation resistance test at either the default value or the last voltage used, if edited during a test sequence.

The measurement can be run in two different ways:

- Standard insulation resistance test
- Extended test that checks the insulation resistance. This test will continue without stopping. During this extended test, the instrument also supports advanced insulation diagnostics, including Polarisation Index (PI) and Dielectric Absorption Ratio (DAR) measurements. These time-based ratio tests provide additional diagnostic information into insulation condition and moisture content, while a DC test voltage is applied.

#### **Polarisation Index (PI)**

The Polarisation Index is calculated as:

$$PI = \text{Insulation resistance at 10 minutes} \div \text{Insulation resistance at 1 minute}$$

A rising resistance over time indicates clean, dry insulation, while low PI values may indicate moisture or contamination. General guidance:

- $PI < 1.0$  – Poor insulation
- $PI 1.0$  to  $2.0$  – Marginal
- $PI \geq 2.0$  – Good insulation

#### **Dielectric Absorption Ratio (DAR)**

The Dielectric Absorption Ratio is a shorter ratio test for quick assessment and calculated as:

$$DAR = \text{Insulation resistance at 60 seconds} \div \text{Insulation resistance at 30 seconds}$$

General guidance:

- $DAR < 1.25$  – Questionable insulation
- $DAR \geq 1.6$  – Good insulation



### Note

If a user were to conduct a test between the positive PV connector and the PV frame, they would need to insert the yellow 4 mm to MC4 lead into the black 4 mm terminal.

1. Press the **Menu** button.
  - ↳ Main menu opens.
2. Select **Manual Mode**.
  - ↳ All available test options are displayed.
3. Use the **directional buttons** to select **R<sub>ISO</sub>**.
4. Press function button 2 to confirm. The button illuminates green.
5. Connect the black MC4 test lead with the instrument and the PV panel.
6. Connect the red MC4 test lead with the instrument and the PV panel using the alligator clip.



### Note

If the test is to be performed at two other points, red and black test leads with alligator clips or test probes can be used for a more suitable connection.

7. Press the corresponding directional button of the instrument to select the required voltage.
8. Press function button 2 to start the measurement.
  - Pressing the button for a short time will run the standard insulation resistance test.
  - Pressing and holding the button for 3 seconds will start the extended test.



### WARNING

#### Risk of electrical shock

On completion of the test, a warning icon Discharging may appear to indicate that the instrument is discharging any stored voltage that may be present after the completion of the test.

- Do not touch the object under test.
  - Wait until discharge has been completed before you remove the connected test leads.
- 
- The test starts. Animation indicates that the test is in progress.
  - ↳ Measured values are displayed on screen.

---

### 9.3.4 Panel Voltage

The panel voltage mode is used to check the open circuit voltage and short circuit current in manual mode. In addition, AC and negative DC voltages can be measured.

1. Press the **Menu** button.
  - ↳ Main menu opens.
2. Select **Manual Mode**.
  - ↳ All available test options are displayed.
3. Use the **directional buttons** to select **Panel Voltage**.
4. Press function button 2 to confirm.
5. Connect the MC4 test leads with the instrument (optional: test probes with alligator clips) and the PV panel.



#### Note

In case the panel characteristics are measured, use the 4 mm to MC4 connectors. For other measurements, e.g. AC voltage, the red and black 4 mm test probes with alligator clips can be used.



#### Note

Once connected to the panel, the instrument will measure the open circuit voltage. If the instrument detects an AC voltage or a negative DC voltage, this will be displayed.  
The test sequence will be inhibited, and the start condition will not initiate the test.

6. Press function button 2 to start the measurement.
  - ↳ Test starts. A circular animation indicates that the test is in progress.
  - ↳ Measured values are displayed.

---

## 9.3.5 Continuity

### Connection

#### Continuity Test – Test Lead Null

- ↳ Result must be 0
- ↳ The result must not change



#### Continuity Test – Continuity Measurement



1. Press the **Menu** button.
  - ↳ Main menu opens.
2. Select **Manual Mode**.
  - ↳ All available test options are displayed.
3. Use the **directional buttons** to select **Continuity**.
4. Press function button 2 to confirm.
5. Optional: To perform an offset compensation, short the test leads together (see connection figure) and press the right direction arrow Null.
6. Connect the 4 mm test leads with the instrument (optional: test probes with alligator clips) and the PV panel.
7. Press function button 2 to start the measurement.
  - ↳ Test starts. A circular animation indicates that the test is in progress.
  - ↳ Measured values are displayed.



---

### 9.3.6 Current Clamp (Measurement via PV:1500 Clamp)

#### Connection

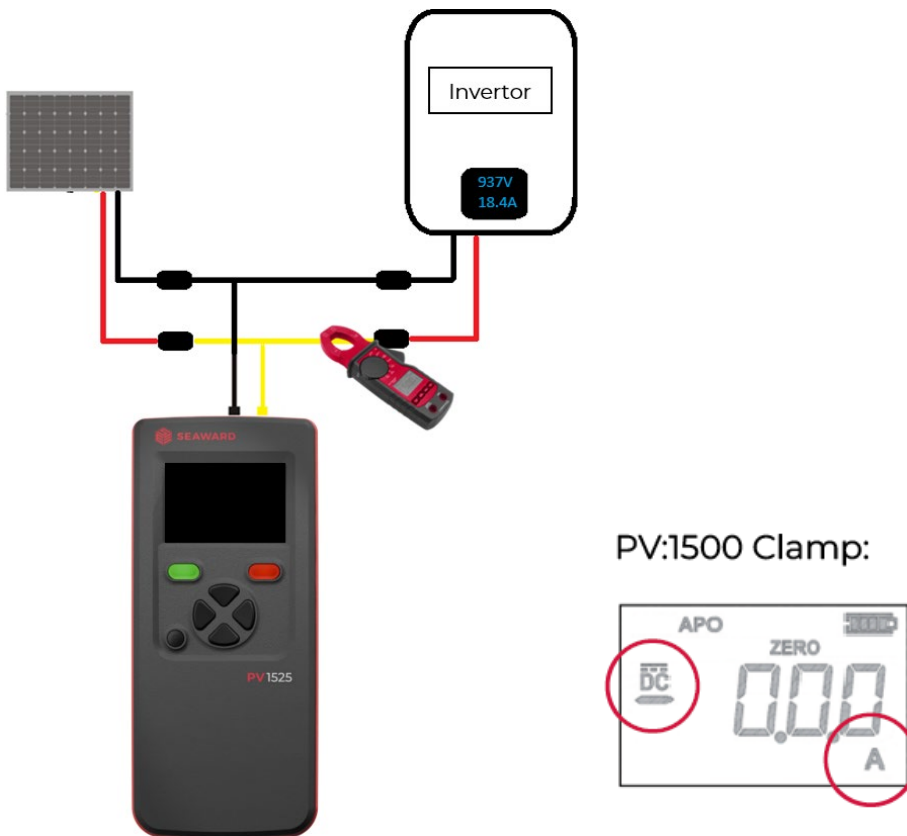

- ✓ The inverter is switched off or correctly isolated.
  - ✓ PV:1500 Clamp is connected to the instrument.
  - ✓ The Bypass measurement leads for power measurement (601A1201) is on hand for tapping into the connection between inverter and solar module(s).
1. Remove input cables from inverter.
  2. Connect the yellow test lead with the input cable and the inverter.
  3. Connect the black test lead with the input cable and the inverter.
  4. Connect the yellow and black MC4 leads with the instrument.
  5. Set the PV:1500 Clamp to **A AC/DC** and select the DC measurement mode (see product documentation).
  6. Press the **Menu** button.
    - ↳ Main menu opens.
  7. Select **Manual Mode**.
    - ↳ All available test options are displayed.
  8. Use the **directional buttons** to select **Current Clamp**.
    - ↳ The instrument enters test mode for the selected test.
    - ↳ Status indicator shows **Connecting** and switches to **Connected**.
  9. Turn power to the inverter on.
    - ↳ The instrument displays measured values.

10. Place the PV:1500 Clamp around the black test lead.
  - ↳ Measured values of the black test lead are displayed on the instrument and the clamp.
11. Place the clamp meter around the yellow test lead.
  - ↳ Measured values of the yellow test lead are displayed on the instrument and PV:1500 Clamp.



### Tip

For the most accurate reading ensure to Zero-out the clamp by pressing and holding the **SELECT / ZERO** button for two seconds until the **ZERO** icon is displayed above the reading.

## 9.4 Downloading Test Results

Downloading data from the instrument requires a mobile device and PV:Sync Mobile app.

### Transfer to PV:Sync Mobile App

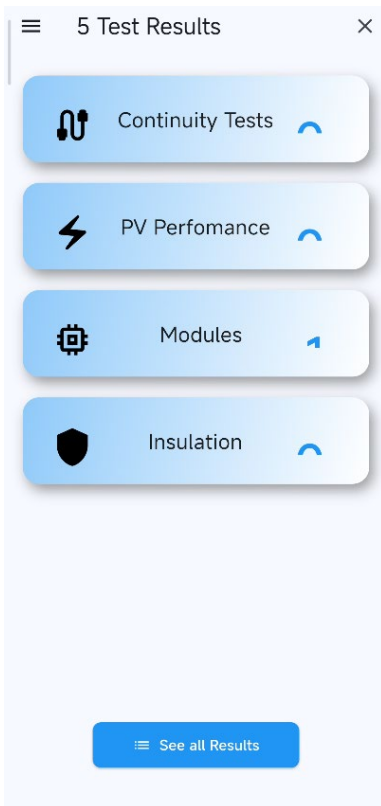

- ✓ Bluetooth® is connected on both devices.
  - ✓ Results are stored in the instrument.
1. Install the PV:Sync Mobile app: You can find it in the Google Play Store (app by Seaward Group) or in the Apple App store (app by Seaward Electronics Ltd.).
  2. Start the App.
  3. Scan for devices.
  4. From list select your instrument (the serial number helps you find it) and click **Connect**.
  5. Follow the Bluetooth® pairing instructions on the screen (the default key is 111111).
    - ↳ App and device are connected.
  6. Select **Sync Data**.
    - ↳ Test results are displayed.

### Further Usage of Downloaded Data With SolarCert PV Reporting Software

With the SolarCert PV reporting software, you can download and manage recorded results and produce easy to read and professional reports. See chapter 9.5 Using the SolarCert PV Reporting Software.

## 9.5 Using the SolarCert PV Reporting Software

The software can be downloaded here:

<https://www.seaward.com/gb/products/solar/software-and-apps/389a950-solarcert-pv-reporting-software/>

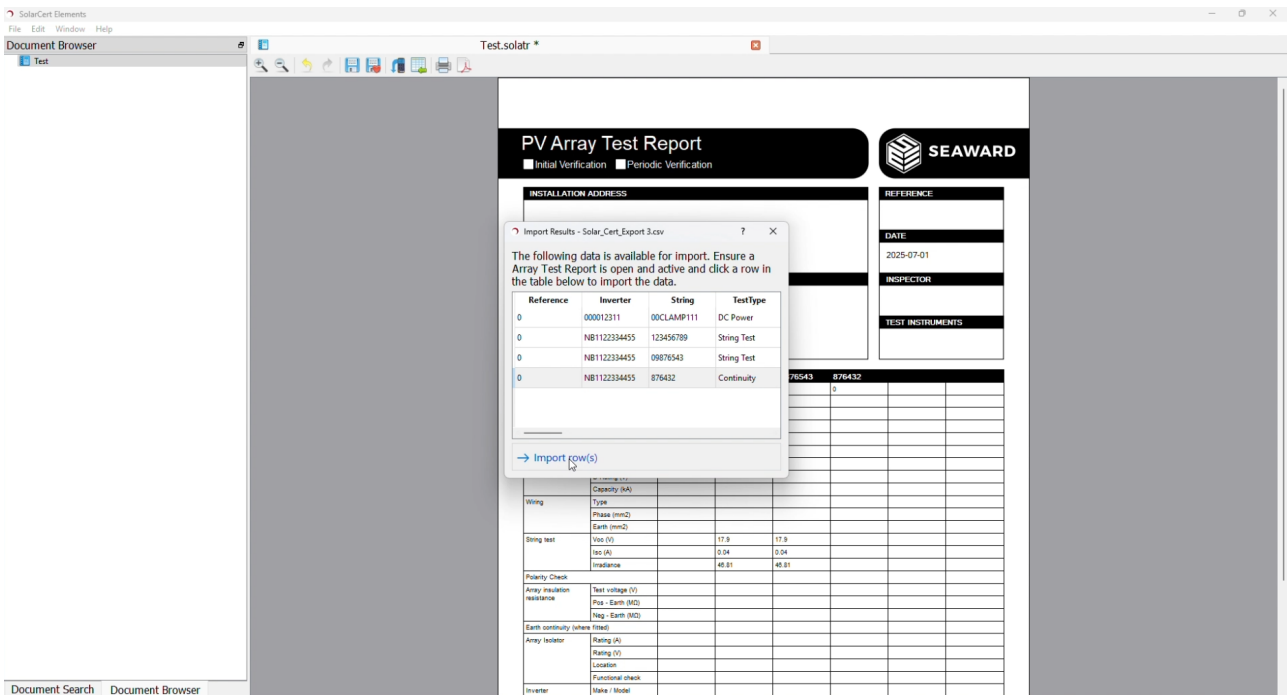

1. Download and install the SolarCert PV Reporting software.
  2. Open the SolarCert PV Reporting software.
  3. Go to **File** and select **New PV Array Test Report**.
  4. Name the new test report.
  5. Open the new test report with a double-click.
  6. Click on the **Import** button with the little green arrow and select your exported .csv file for import.
  7. Select the rows you want to import. It is possible to select and import the rows one by one or a maximum of 6 into the report at the same time.
- ↳ The test report is imported directly into the created new test report file.
8. Close the import window by clicking **X** at the top.

---

## 10. Storage and Transport

### ATTENTION

#### Improper storage

Damage to the product and measuring error due to environmental influences.

- Store the instrument in a protected location and only within the limits of permissible ambient conditions. The ambient conditions (temperature, humidity etc.) can be found on page 16.

### ATTENTION

#### Improper transport

Damage to the product and measuring error.

- Transport the instrument only within the limits of permissible ambient conditions (temperature, humidity etc.). The ambient conditions (temperature, humidity etc.) can be found on page 16.
- Only use the original carry case to transport the instrument.

## 11. Internal Instrument Log

The instrument has an internal log which automatically records certain information (e.g. errors, number and type of tests run, maximum and minimum values, total run time). Overview with all collected data: page 57.

This data can and will be used for diagnostic purposes during technical support, service, and repairs. You can download the log as a CSV file for your own purposes.

✓ You have installed the PV:Sync Mobile app on your mobile device. See chapter 9.4.

✓ Your instrument is paired with your mobile device via Bluetooth®.

1. Open the PV:Sync Mobile app.
  2. Open **Settings**.
  3. Within the first section **Database Management**, open **Download Diagnostic Data**.
- ↳ The app will connect to the instrument and automatically download the log.

---

## 12. Maintenance

### 12.1 Cleaning



#### **DANGER**

##### **Life endangering due to electric shock!**

The instrument and its accessories are operated with electrical power, therefore there is a general risk of electric shock. This can be fatal or cause serious injuries.

- The instrument, the accessories and all connected conductors must be voltage-free before and during cleaning. Switch the test instrument off and disconnect it from the mains power supply.
- Never immerse the instrument/accessories in water or other fluids.
- Never touch the instrument/accessories with wet or moist hands.

---

#### **ATTENTION**

##### **Unsuitable cleaning agents**

Unsuitable cleaning agents such as aggressive or abrasive cleansers result in damage to the instrument/accessories.

- Use a dry cloth for cleaning.
- 

Keep the outside surfaces of the instrument and any accessories clean.

### 12.2 Calibration

Use of your instrument and the resulting stress influence the instrument and lead to deviation from warranted accuracy values.

In the case of strict measuring accuracy requirements, as well as in the event of severe stressing (e.g. severe climatic or mechanical stress), we recommend a relatively short calibration interval of once per year. If this is not the case, a calibration interval of 12 months is usually adequate.

Please contact our service department for calibration services, see page 53.



#### **Note**

The instrument is fully calibrated and found to be within the specified performance and accuracy at the time of production. The Seaward Group provides its products through a variety of channels; therefore, it may be possible that the calibration date on the provided certificate may not represent the actual date of first use.

Experience has indicated that the calibration of this instrument is not affected by storage prior to receipt by the user. We therefore recommend that the recalibration period be based on a 12-month interval from the first date the unit is placed into service.

---

#### **Calibration Reminder Setup**

After approximately 40 boot-ups, the instrument will prompt you to enter the date on which it was placed into service.

---

Once you have entered the date, the instrument automatically calculates the due date of calibration using a 12 month period.

The first reminder appears 1 month before the due date of calibration. The second reminder appears 1 week before the due date of calibration.

From the actual due date onward, a reminder will be shown at every boot-up until calibration has been performed.

You can look up the calibration due date at any time in the **About** screen.



#### Note

You can skip entering the date by pressing the **Home** button. However, you will be asked again with each boot-up.

---

## 12.3 Firmware

### 12.3.1 View firmware version

From the **Main Menu**, press the function button 1. You will then be taken to the **About** screen. This section contains information regarding the firmware, hardware, and serial number. If you press the function button 1 again, the system will return you to the **Main Menu**.

### 12.3.2 Update your firmware

To update the firmware of your instrument, use the **PV:Sync Mobile App**.

✓ The instrument and mobile device are both at least 25 % charged.

1. On the **Home** screen, press **Settings**.
2. Press **Firmware Update**.
3. Start **Update**.



#### Note

You will not be automatically notified when a firmware update is available. Please check the app regularly to see if an update is available.

---

### 13. Troubleshooting

Error Identifier	Error Displayed	Warning Level	Where Displayed	Solution
Information	External voltage present. Please remove any external source.	Medium	Continuity test	Remove input voltage from the measured circuit and retry.
Information			String test (R <sub>ISO</sub> )	Check the measured circuit connection and run the test again. Do not exceed the measurement range. Check if the panel frame is earthed correctly.
Information	Low panel voltage. Ensure correct connection.	Medium	String test	Ensure correct connection to the solar array and run the test again.
Warning	Post check failed.	Critical	String test	Check the connection to the measured circuit and run the test again. Do not exceed the measurement range.
				Check the connection to the measured circuit and run the test again. Do not exceed the measurement range.
Information	I <sub>SC</sub> failed to start.	Medium	String test	Please wait for the running test to finish before attempting to start a new test. Power cycle the instrument.
Information	Panel voltage detected – Disconnect yellow PV+ terminal	Medium	R <sub>ISO</sub> test	Remove the input voltage from the measured circuit.
Warning	Overvoltage detected. Ensure system voltage does not exceed 1500 V.	Medium	String test	Check the connection to the measured circuit. Do not exceed measurement range.
Warning	Current is not zero.	Critical	String test	Check the connection to the measured circuit and run the test again. Do not exceed the measurement range.

Error Identifier	Error Displayed	Warning Level	Where Displayed	Solution
Timeout	No trigger signal.	Medium	String test	Check the connection to the measured circuit and run the test again. Do not exceed the measurement range. Power cycle the instrument.
Warning	Measurement circuit Error 1 – Please retry test. If problem persists, contact service agent.	Medium	String test	Check the connection to the measured circuit and run the test again. Do not exceed the measurement range.
Warning	Measurement circuit Error 2 – Please retry test. If problem persists, contact service agent.	Medium	String test	Check the connection to the measured circuit and run the test again. Do not exceed the measurement range.
Warning	R <sub>ISO</sub> circuit Error 1 – Please retry test. If problem persists, contact service agent.	Medium	R <sub>ISO</sub> test	Check the connection to the measured circuit and run the test again. Do not exceed the measurement range.
Information	Current not stable.	Medium	String test	Check the connection to the measured circuit and run the test again. Do not exceed the measurement range.
Information	Mosfet not ready.	Medium	String test	Check the connection to the measured circuit and run the test again. Do not exceed the measurement range. Power cycle the instrument.
Warning	Power limit exceeded – Reduce string or test with lower irradiance.	Medium	String test	Check the connection to the measured circuit and run the test again. Do not exceed the measurement range. Reduce the string length or test at lower irradiance values.
Warning	Fuse error. Please contact service agent.	Medium	String test	Internal fuse failure. Contact an authorized service agent. The fuse is not user replaceable, do not attempt to replace!



<b>Error Identifier</b>	<b>Error Displayed</b>	<b>Warning Level</b>	<b>Where Displayed</b>	<b>Solution</b>
Warning	High temperature, please allow to cool.	Medium to Critical (temperature-dependent)	String test	Disconnect the instrument and allow it to cool before running further tests.
Warning	Pre-Check Error 1 – Please retry. If problem persists, contact service agent.	Medium	String test	Check the connection to the measured circuit and run the test again. Do not exceed the measurement range.
Warning	Pre-Check Error 2 – Please retry. If problem persists, contact service agent.	Medium	String test	Check the connection to the measured circuit and run the test again. Do not exceed the measurement range.
Warning	Pre-Check Error 3 – Please retry. If problem persists, contact service agent.	Medium	String test	Check the connection to the measured circuit and run the test again. Do not exceed the measurement range.
Warning	Pre-Check Error 4 – Please retry. If problem persists, contact service agent.	Medium	String test	Check the connection to the measured circuit and run the test again. Do not exceed the measurement range.
Warning	Pre-Check Error 5 – Please retry. If problem persists, contact service agent.	Medium	String test	Check the connection to the measured circuit and run the test again. Do not exceed the measurement range.
Information	Pre-Check Error 6 – Please retry. If problem persists, contact service agent.	Medium	String test	Check the connection to the measured circuit and run the test again. Do not exceed the measurement range.
Warning	Pre-Check Error 7 – Please retry. If problem persists, contact service agent.	Medium	String test	Check the connection to the measured circuit and run the test again. Do not exceed the measurement range.

Error Identifier	Error Displayed	Warning Level	Where Displayed	Solution
Warning	Pre-Check Error 8 – Please retry. If problem persists, contact service agent.	Medium	String test	Check the connection to the measured circuit and run the test again. Do not exceed the measurement range.
Warning	R <sub>PE</sub> Circuit Error 1 – Please retry. If problem persists contact service agent.	Medium	Continuity test	Check the connection to the measured circuit and run the test again. Do not exceed the measurement range. If the problem persists, contact an authorized service agent.
Warning	R <sub>ISO</sub> circuit Error 2 – Please retry test. If problem persists, contact service agent.	Medium	Insulation test	Check the connection to the measured circuit and run the test again. Do not exceed the measurement range. If the problem persists, contact an authorized service agent.
Information	R <sub>ISO</sub> result not valid.	Medium	String test	Check the connection to the measured circuit and run the test again. Do not exceed the measurement range.
Warning	Internal Error – If problem persists, contact service agent.	Medium	Continuity test	Power cycle the instrument. If the problem persists, contact an authorized service agent.
		Critical	General	Power cycle the instrument. If the problem persists, contact an authorized service agent.
Information	Incompatible firmware versions. Please update the unit to be able to run any tests.	Medium	General	Check the installed firmware version. Install the compatible firmware version.
Warning	Irradiance varies more than 10%.	Normal	IV Curve	Check the irradiance. Repeat the test when irradiance is more stable.

Error Identifier	Error Displayed	Warning Level	Where Displayed	Solution
Warning	SS:200LR is not connected. Do you want to continue?	Normal	IV Curve	Confirm the test without the SS:200LR or connect the SS:200LR.
Warning	Irradiance is less than 700 W/m <sup>2</sup> . Do you want to continue?	Normal	IV Curve	Confirm to test with low irradiance or repeat the test when the irradiance is above 700 W/m <sup>2</sup> .
Information	The battery is low.	Medium	All tests	Charge the battery.
Warning	Please restart. If problem persists contact service agent.	Critical	All tests	Restart the unit. If the problem persists, contact a service agent.
Warning	Unstable measurement 1 – Please retry test with high irradiance.	High	IV Curve	Repeat the test when irradiance is more stable. If the problem persists, contact a service agent.
Warning	Unstable measurement 2 – Please retry test with high irradiance.	High	IV Curve	Repeat the test when irradiance is more stable. If the problem persists, contact a service agent.
Warning	Unstable measurement 3 – Please retry test with high irradiance.	High	IV Curve	Repeat the test when irradiance is more stable. If the problem persists, contact a service agent.
Warning	Unstable measurement 4 – Please retry test with high irradiance.	High	IV Curve	Repeat the test when irradiance is more stable. If the problem persists, contact a service agent.
Warning	Unstable measurement 5 – Please retry test with high irradiance.	High	IV Curve	Repeat the test. If the problem persists, contact a service agent.
Warning	Isc > 25 A.	High	String Test / IV Curve	Reduce the panel current.
Information	Calibration reminder date	Status	40 <sup>th</sup> boot-up	Enter the date the instrument entered service. Calibration date will be calculated at 12 months automatically.

---

## 14. Repair

If your instrument requires repair, please contact our service department, see page 53.



### Note

#### Loss of warranty and guarantee claims

Unauthorized modification of the instrument is prohibited. This also includes opening the instrument.

If it can be ascertained that the instrument has been opened by unauthorized personnel, no guarantee claims can be honored by the manufacturer with regard to personal safety, measuring accuracy, compliance with applicable safety measures or any consequential damages.

- The device may only be repaired or opened by authorized, qualified personnel who are familiar with the associated dangers.
- Original replacement parts may only be installed by authorized, qualified personnel.
- The instrument may not be placed back into operation until troubleshooting and repair have been performed, and calibration and dielectric strength have been tested and approved at our factory, or at one of our authorized service centers.



### Note

#### Data protection

Data can be stored in the instrument. This may include personal and/or sensitive data.

Back up your data before sending the instrument for repair.

Also, be aware of the owner's or end user's own responsibility with regard to protecting personal and other potentially sensitive data in the instrument before sending it for repair.

---

## 15. Service and Contact

### GERMANY:

GMC-I Service GmbH  
Beuthener Straße 41  
90471 Nürnberg  
Deutschland



+49 911 817718-0



service@gossenmetrawatt.com

For more information on service or calibration visit:

[gmci-service.com/en](https://gmci-service.com/en)

### REST OF WORLD:

Calibrationhouse (UK)  
11 Bracken Hill  
South West Industrial  
Estate  
Peterlee  
County Durham  
SR8 2LS



+44 (0) 191 587 8737



service@calibrationhouse.com

For more information on service or calibration visit:

[calibrationhouse.com](https://calibrationhouse.com)

---

## **16. Certifications**

### **16.1 CE Declaration**

The instrument fulfills all requirements of applicable EU directives and national regulations. We confirm this with the CE mark.

A printed version of the CE declaration is included in the scope of delivery.

### **16.2 UKCA marking**

The instrument fulfills all requirements of applicable UK requirements. We confirm this with the UKCA marking.

A printed version of the UKCA declaration is included in the scope of delivery.

### **16.3 Calibration Statement and Certificate**

A calibration certificate is included with the instrument.

The instrument is fully calibrated and found to be within the specified performance and accuracy at the time of production. The Seaward Group provides its products through a variety of channels; therefore it may be possible that the calibration date on the certificate provided may not represent the actual date of first use.

Experience has indicated that the calibration of this instrument is not affected by storage prior to receipt by the user. We therefore recommend that the recalibration period be based on a 12-month interval from the first date the unit is placed in to service.

Please contact us for calibration services, see page 53.

---

## 17. Disposal and Environmental Protection

Proper disposal makes an important contribution to the protection of our environment and the conservation of natural resources.

### ATTENTION

#### Environmental damage

Improper disposal results in environmental damage.

Follow the instructions concerning return and disposal included in this section.

---

### 17.1 Disposal of Old Devices, Batteries and Rechargeable Batteries

Old devices and (rechargeable) batteries contain valuable raw materials that can be recycled, as well as hazardous substances which can cause serious harm to human health and the environment, and they must be recycled and disposed of correctly.



The symbol depicting a crossed-out garbage can on wheels refers to the legal obligation of the owner or end-user not to dispose of old devices and batteries or rechargeable batteries with unsorted municipal waste ("household trash"). The (rechargeable) batteries must be removed from the old device (where possible) without destroying them and the old device and the (rechargeable) batteries must be disposed of separately. The type and chemical composition of the (rechargeable) battery are indicated on the battery's labelling. If the abbreviations "Pb" for lead, "Cd" for cadmium or "Hg" for mercury are included, the (rechargeable) battery exceeds the limit value for the respective metal.

You are obliged to comply with respective local requirements and implement them correctly on site. Further information can be obtained, for example, from the responsible authorities or the local distributor.

Please also observe the owner's or end user's responsibility with regard to deleting personal data, as well as any other sensitive data, from old devices before disposal.

### 17.2 Disposal of Packaging Materials

Packaging and its parts must be correctly disposed of separately from unsorted municipal waste ("household trash").

You are obliged to comply with respective local requirements and implement them correctly on site. Further information can be obtained, for example, from the responsible authorities or the local distributor.

We recommend retaining the original packaging materials in case you might require servicing or calibration in the future.



### WARNING

#### Danger of asphyxiation resulting from foils and other packaging materials

Children and other vulnerable persons may suffocate if they wrap themselves in packaging materials, or their components or foils, or if they pull them over their heads or swallow them.

- Keep packaging materials, as well as their components and foils, out of the reach of babies, children and other vulnerable persons.
-

---

### **17.3 Regulations for the Federal Republic of Germany**

The following comments refer specifically to the legal situation in the Federal Republic of Germany.

Old devices, electrical or electronic accessories and batteries or rechargeable batteries

Old devices, electrical or electronic accessories, batteries and rechargeable batteries used in Germany can be returned free of charge to Gossen Metrawatt GmbH or the service provider responsible for their disposal in compliance with applicable regulations, in particular laws concerning packaging and hazardous goods. Batteries and rechargeable batteries must be returned in the discharged state or with appropriate precautions against short circuiting. Further information regarding returns can be found on our website.

Packaging Materials

Packaging which is not subject to so-called system participation is returned to the appointed service provider. Further information regarding returns can be found on our website.



## Appendix A: Internal Log Information

Field	Content	Comment
boot_count	Absolute number of boots	This value might differ from the boot count register. The register shows a relative value. That register is reset at the end of calibration, but the value here will never be reset.
error	Most recent errors	The limited number of errors are kept in this file. When reached the end of the list, the older errors will be overwritten by new ones.
error_cursor	Storing the location of the latest error	This is for internal use. It helps to know where to put the next error in the file.
exceed_power_test_count	Number of tests which reached the power limit.	
iv_curve-xxx	This will be one of the latest IV test results. The xxx shows the test number. We keep the last 10 tests.	The content shows <ul style="list-style-type: none"> <li>■ Date and time of the test</li> <li>■ <math>V_{oc}</math></li> <li>■ <math>I_{sc}</math></li> </ul>
iv_test_count	Number of the IV test	
peak_current	Maximum measured test current	The value is in mA
peak_inrush	Maximum inrush current	
peak_inrush_voc_isc	$V_{oc}/I_{sc}$ related to the peak inrush current	This file has: <ul style="list-style-type: none"> <li>■ Date and time of the test</li> <li>■ The peak inrush</li> <li>■ <math>V_{oc}</math></li> <li>■ <math>I_{sc}</math></li> </ul>

Field	Content	Comment
peak_voltage	Maximum voltage connected to the terminal	
riso_auto_test_count	Total number of R <sub>ISO</sub> tests in the String Test or in the IV Curve Trace	
riso_p2p-xxx	Last 10 R <sub>ISO</sub> tests	This file has: <ul style="list-style-type: none"> <li>▪ Date and time of the test</li> <li>▪ V<sub>ISO</sub> set voltage (250<sup>^</sup>V, 500 V, etc.)</li> <li>▪ R<sub>ISO</sub></li> <li>▪ Actual generated V<sub>ISO</sub></li> </ul>
riso_p2p_test_count	Total number of R <sub>ISO</sub> tests	
rpe-xxx	Last 10 results of the Continuity test	This file has: <ul style="list-style-type: none"> <li>▪ Date and time of the test</li> <li>▪ Measured R<sub>PE</sub></li> </ul>
rpe_test_count	Total number of Continuity tests	
temperature_a_max_celcius	Maximum ambient temperature	
temperature_b_max_celcius	Maximum IR temperature	
temperature_b_min_celcius	Minimum IR temperature	
total_test_count	Overall up-time of the unit	
voc_isc-xxx	Last 10 results of the I <sub>sc</sub>	This file has: <ul style="list-style-type: none"> <li>▪ Date and time of the test</li> <li>▪ V<sub>ISO</sub> set point</li> <li>▪ V<sub>OC</sub></li> <li>▪ I<sub>sc</sub></li> <li>▪ R<sub>ISO</sub></li> <li>▪ Actual generated V<sub>ISO</sub></li> </ul>



# SEAWARD

GMC-INSTRUMENTS GROUP

## Head Office

 +44 (0) 191 586 3511       [sales@seaward.com](mailto:sales@seaward.com)

 Seaward, 15-18 Bracken Hill, South West Industrial Estate,  
Peterlee, County Durham, SR8 2SW, United Kingdom

## Representation in Germany

 +49 911 8602-0       [sales@gossenmetrawatt.com](mailto:sales@gossenmetrawatt.com)

 Gossen Metrawatt GmbH, Südwestpark 15,  
90449 Nürnberg, Deutschland

[seaward.com](http://seaward.com)

Part Number: 601A522

Revision: 5 (04/2026)