HAL Series Electrical Safety Tester

Quick Start Guide



Seaward Electronic Ltds Ltd.
Bracken Hill, South West Industrial Estate,
Peterlee, Co. Durham. SR8 2SW. England.
Tel: +44 (0)191 586 3511 Fax: +44 (0)191 586 0227
www.seaward.co.uk

Limited Warranty & Limitation of Liability

Seaward Electronic Limited guarantees this product for a period of 1 year. The period of warranty will be effective at the day of delivery.

© Copyright 2013

All rights reserved. Nothing from this edition may be multiplied, or made public in any form or manner, either electronically, mechanically, by photocopying, recording, or in any manner, without prior written consent from CLARE. This also applies to accompanying drawings and diagrams.

Due to a policy of continuous development CLARE reserves the right to alter the equipment specification and description outlined in this publication without prior notice and no part of this publication shall be deemed to be part of any contract for the equipment unless specifically referred to as an inclusion within such contract.

1. Important Info

The aim of this quick start guide is to provide simple set up options in order to configure and use the HAL. It is not an exhaustive instructional document, for full details please refer to the supplied instruction manual.

The information contained in this document assumes that all relevant risk assessments and safety steps have been performed prior to operation and that all users of the equipment have been appropriately trained.

2. Registering your HAL Tester

Seaward Group guarantees this product for a period of one year, upon successful registration of the product. The period of warranty will be effective at the day of delivery.

In order to ensure the continued performance of this product Seaward recommends that this tester be serviced and calibrated on an annual basis, by Seaward Group or any of Seaward’s authorised service facilities using Seaward approved parts and components.

Any unauthorised modifications, tampering or physical damage sustained through negligent use or handling will void the warranty.

3. HAL Functions

There are 5 variants of the HAL, please refer to the table below to view the functions available on your model

| | AC & DC Hipot | IR | Earth Bond | Load 5kVA & Leakage | Load 1000VA & Leakage | Rear Test Port | Multiple Channel Scanner |
|---------|---------------|----|------------|---------------------|-----------------------|----------------|--------------------------|
| HAL101 | x | x | | | | | |
| HAL102 | x | x | | | | | x |
| HAL103 | x | x | x | | | x | |
| HAL104 | x | x | x | x | | x | |
| HAL LED | x | x | x | | x | x | |

4. What's in the Box

| | HAL101 | HAL102 | HAL103 | HAL 104 | HAL LED |
|--------------------------------------|--------|---------|--------|---------|---------|
| Test Instrument | 1 | 1 | 1 | 1 | 1 |
| Power Supply Lead | 1 | 1 | 1 | 1 | 1 |
| Hipot Clip & Lead | 1 | 5 Pairs | 1 | 1 | 1 |
| Hipot Probe & Lead | 1 | | 1 | 1 | 1 |
| Earth Bond Probe | | | 1 | 1 | 1 |
| Test Output Box | | | 1 | 1 | 1 |
| Guard Plug | 1 | 1 | 1 | 1 | 1 |
| External Control Connectors and Pins | 2 | | 2 | 2 | 2 |

5. HAL Tour

All HAL models have the same front end, however the connections on the Rear of the HAL will differ dependant upon the model. Please see below for your model and the connections / options available

Front Panel – All Models

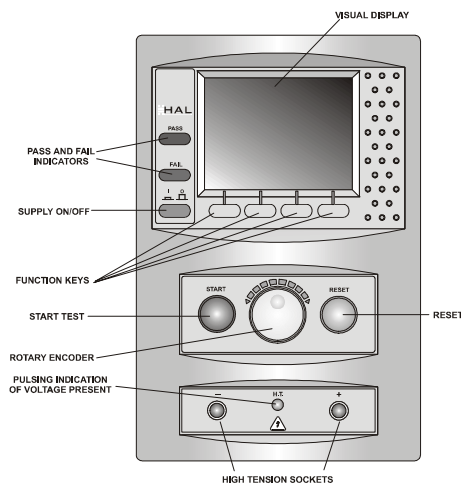

- Visual Display – Main Interface Screen
- Pass / Fail Indicators – Indicate test status during and after a test
- On / Off Button – Supplies Mains Power to operate the HAL
- Function Keys –Short cut options, function will differ dependant upon current screen
- Start Button – Used to confirm selections and Start Tests
- Reset Button – Used to abort selections and Stop Tests
- Rotary Encoder – Used to scroll Menu Options and Alter Test Parameters
- Hi Tension Port Positive – Used for the Output of Test Voltages
- Hi Tension Port Negative – Used as a return to measure any current flow
- Hi Tension Presence Lamp – Used to indicate the HAL is performing a High Voltage Test

Rear Panel – HAL101

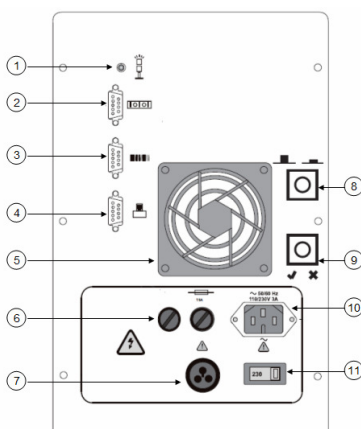

1. Beacon Port – For connection to a safety status beacon (Part Number H-5027)
2. Communications Port – For communication with the HAL, used for download of data and remote control
3. Barcode Port – For connection to an RS-232 Barcode Scanner to allow input of Product ID's and test sequence selection (Part Number 194A922)
4. Printer Port – For connection to a printer for output of data results. Can be used with the Desk Test n Tag printer for Pass / Fail labels (Part Number 312A912)
5. Cooling Fan – Allow airflow to the internal circuitry, please do not cover.

6. External Fuse – User replaceable
7. Guard Switch Socket – Used as a safety interlock, can be used as a start condition but will inhibit the test if the guard is opened. Should be a zero volt connection.
8. Remote Start Socket – Allows for remote start / stop switches to be connected to the HAL, These will function as per the Green and Red buttons on the front panel of the HAL. Should be a zero volt connection
9. Status Indicator Socket – Outputs a signal to indicate Pass or Fail condition, which could be utilised by a PLC for example. The status connections are unpowered and require an external supply voltage to operate. See manual for full details
10. Mains Supply Socket – For connection to the mains supply to power the HAL101.
11. Mains Voltage Selector Switch – Sets the Mains operating voltage for the HAL, switches between 115V and 230V. Please ensure the selector switch is in the correct position prior to powering on the HAL.

Rear Panel – HAL102

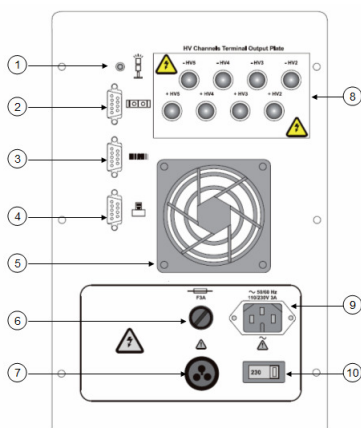

1. Beacon Port – For connection to a safety status beacon (Part Number H-5027)
2. Communications Port – For communication with the HAL, used for download of data and remote control
3. Barcode Port – For connection to an RS-232 Barcode Scanner to allow input of Product ID's and test sequence selection (Part Number 194A922)
4. Printer Port – For connection to a printer for output of data results. Can be used with the Desk Test n Tag printer for Pass / Fail labels (Part Number 312A912)

5. Cooling Fan – Allow airflow to the internal circuitry, please do not cover.
6. External Fuse – User Replaceable
7. Guard Switch Socket – Used as a safety interlock, can be used as a start condition but will inhibit the test if the guard is opened. Should be a zero volt connection.
8. Test Voltage Output Ports – 4 Pairs of Test Output ports, totalling 5 sets of ports including the front ports.
9. Mains Supply Socket – For connection to the mains supply to power the HAL102.
10. Mains Voltage Selector Switch – Sets the Mains operating voltage for the HAL, switches between 115V and 230V. Please ensure the selector switch is in the correct position prior to powering on the HAL

Rear Panel – HAL103

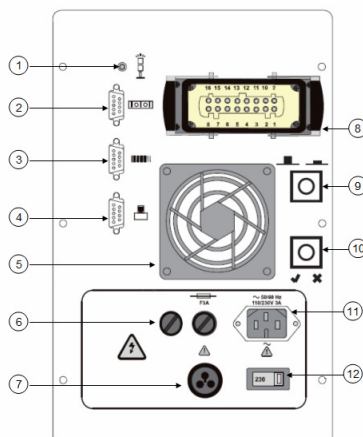

1. Beacon Port – For connection to a safety status beacon (Part Number H-5027)
2. Communications Port – For communication with the HAL, used for download of data and remote control
3. Barcode Port – For connection to an RS-232 Barcode Scanner to allow input of Product ID's and test sequence selection (Part Number 194A922)
4. Printer Port – For connection to a printer for output of data results. Can be used with the Desk Test n Tag printer for Pass / Fail labels (Part Number 312A912)
5. Cooling Fan – Allow airflow to the internal circuitry, please do not cover.
6. External Fuse – User Replaceable

7. Guard Switch Socket – Used as a safety interlock, can be used as a start condition but will inhibit the test if the guard is opened. Should be a zero volt connection.
8. Rear Test Output connection – Test outputs for rear port, connection point for the supplied Output box.
9. Remote Start Socket – Allows for remote start / stop switches to be connected to the HAL, These will function as per the Green and Red buttons on the front panel of the HAL. Should be a zero volt connection
10. Status Indicator Socket – Outputs a signal to indicate Pass or Fail condition, which could be utilised by a PLC for example. The status connections are unpowered and require an external supply voltage to operate. See manual for full details
11. Mains Supply Socket – For connection to the mains supply to power the HAL103.
12. Mains Voltage Selector Switch – Sets the Mains operating voltage for the HAL, switches between 115V and 230V. Please ensure the selector switch is in the correct position prior to powering on the HAL.

Rear Panel – HAL 104 & LED

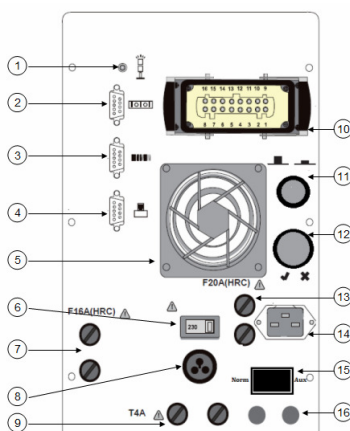

1. Beacon Port – For connection to a safety status beacon (Part Number H-5027)
2. Communications Port – For communication with the HAL, used for download of data and remote control
3. Barcode Port – For connection to an RS-232 Barcode Scanner to allow input of Product ID's and test sequence selection (Part Number 194A922)

4. Printer Port – For connection to a printer for output of data results. Can be used with the Desk Test n Tag printer for Pass / Fail labels (Part Number 312A912)
5. Cooling Fan – Allow airflow to the internal circuitry, please do not cover.
6. Mains Voltage Selector Switch – Sets the Mains operating voltage for the HAL, switches between 115V and 230V. Please ensure the selector switch is in the correct position prior to powering on the HAL.
7. External Fuse – User Replaceable
8. Guard Switch Socket – Used as a safety interlock, can be used as a start condition but will inhibit the test if the guard is opened. Should be a zero volt connection.
9. External Fuse – User Replaceable
10. Rear Test Output connection – Test outputs for rear port, connection point for the supplied Output box.
11. Digital Output Socket –Allows for connection to the 8 Digital Outputs, which can be used for relay control, as an example. Please refer the full manual for pin out information
12. Analogue Input Socket - Status Indicator Socket – Outputs a signal to indicate Pass or Fail condition, which could be utilised by a PLC for example. The status connections are unpowered and require an external supply voltage to operate. See manual for full details
13. External Fuse – User Replaceable
14. Mains Supply Socket – For connection to the mains supply to power the HAL101.
15. Power Test Voltage Selector Switch – Select between Norm, and Aux. Norm will use the incoming mains supply powering the HAL and route it through to the output box to supply power to the EUT. Aux will route through an external voltage supplied via the Auxiliary Voltage input ports.
16. Auxiliary voltage Inlet – 2 x 4mm sockets to allow input of external Aux voltage supply for the Power & Leakage tests. Supplied voltage can be 50/60Hz and between 80 – 300VAC

6. Navigating the HAL Menu

The HAL Menu System is driven primarily using the Rotary Encoder and Green (START) and Red (RESET) buttons.

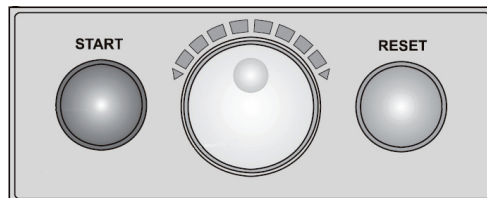

The function of the rotary encoder is to navigate through the HAL menu system. Rotating the wheel clockwise will move the cursor forward or increase Test Parameters, where as rotating the wheel anti clockwise, will move the cursor backwards or reduce Test Parameters

The Start or Green Button has the primary function of starting a Test, however when configuring the HAL it is also used to cycle through available options, for example when configuring the system, the memory can be turned off. When this option is navigated to and highlighted, pressing the green button will cycle between ON and OFF.

The Red or Abort Button has the primary function of aborting a Test in progress, but it can also be used to escape from a particular screen and return back to the previous menu

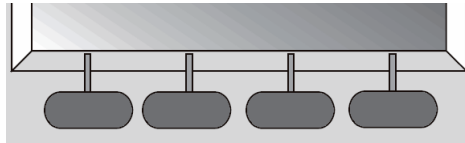

The Four function keys directly beneath the LCD Display of the HAL are generally used as short cuts to useful options within a particular screen. These keys serve as single press options to save time navigating through the HAL menu structure.

TIP. Where a function key displays ROTATE FIELD, selecting this option will allow the rotary encoder to be used to increase test parameters. This is particularly useful when there are many options available, such as selecting a test voltage.

7. System Configuration

The System Configuration menu is used to define how the HAL behaves when performing tests. This section is shown using a HAL104 menu screen. Some of the options shown may not be available on other models due to their functionality.

System Configuration can be found by navigating from the MAIN MENU to SETUP > SYSTEM CONFIGURATION.

```
-----SYSTEM CONFIGURATION-----
PRODUCT NUMBER: BLANK
ON TEST FAILURE: END PRODUCT
TEST TYPE: ANY

TEST MODE: NORMAL
DC HIPOT RAMP DOWN: AT LEAST 1.0S
DC IR RAMP DOWN: AT LEAST 0.5S
DC IR VOLTAGES: LIMITED
COMMENTS: ALWAYS
STORE RESULTS: YES
AFTER TEST: MENU

DATE FORMAT: DD/MM/YYYY
ROLL PRINTER
PASSWORD PROTECTION OPTIONS
EDIT EXTERNAL SIGNAL NAMES
OK
```

1. PRODUCT NUMBER – Allows a unique reference to be entered and stored against the test results;

BLANK – A blank field for data to be entered

REPEAT LAST – Displays the last used reference number

INCREMENT LAST – Automatically increments a reference number

NOT REQUIRED – A reference number will not be requested

2. ON TEST FAILURE – Defines how the HAL will react when a test fails;

END TEST – The test will be completed and recorded as a fail

FAILURE MENU – Will allow the user to confirm the next step including the ability to perform the failed test again

3. TEST TYPE – Defines how the user can select which test sequence to perform

ANY – Provides a list of all available test sequences, the user will use the Rotary Encoder and Green button to select the test.

BARCODE ONLY – Allows the user to select a test sequence by scanning a barcode with the same description as the test sequence name

FIXED – The HAL is fixed to perform only one test sequence, a further option will become available to choose the test sequence to be performed.

4. TEST MODE – NOT USED

5. DC HIPOT RAMP DOWN – Allows a default ramp down time of DC Hipot Test Voltage on all test sequences to ensure discharging of stored energy.

6. DC IR RAMP DOWN - Allows a default ramp down time of DC Insulation Resistance High Voltage on all test sequences to ensure discharging of stored energy.
7. DC IR VOLTAGES – Allows the full range of the DC Hipot test voltages to be selected used for Insulation Resistance Tests when creating test sequences.

LIMITED – Fixed voltages of 250/500/1000V

UNLIMITED – Allows full 0 -6000V range to be used

8. COMMENTS - Allows for comments to be added on completion of a test

ALWAYS – Comments field will display after any test is finished

ON PASS – Comments field will become active only when a test passes

ON FAILURE – Comments field will become active only when a test fails

NEVER – Comments field disabled

9. STORE RESULTS – Defines if the memory is used

YES – Memory is on and results will be stored

NO – Memory is off and results will not be stored

10. AFTER TEST – Defines what action the HAL takes on completion of a test

MENU – Displays a list of next steps which allows the user to choose from

NEW TEST – Returns to the start of the New Test function

DOWNLOAD, NEW TEST – Outputs the results of the test, and then returns to the New Test function

DOWNLOAD,MENU - Outputs the results of the test, and then displays a list of next available steps

11. DATE FORMAT – Allows the user to configure the displayed date format

DD/MM/YYYY or MM/DD/YYYY

12. ROLL PRINTER – Configure the connection to a roll printer.
Note this is not the configuration for the Desk Test n Tag printer.
13. PASSWORD PROTECTION OPTIONS – Allows the user to select which functions / menus are protected behind a password (if configured)
14. EDIT EXTERNAL SIGNAL NAMES – Allows the user to give unique references to the External Control Port names.

8. Creating a Test Sequence

The following section should be used as a guide to creating a test sequence. This will show a completed test and define all the parameters that can be altered. Test that can be configured across the range include;

Dielectric Strength (HIPot) 50 & 60Hz
Insulation Resistance
Earth Bond (50 & 60 Hz)
Power & Leakage
Power and Touch Leakage

Access to the Test Settings editor can be found by navigating from the MAIN MENU to SETUP> EDIT TEST SETTINGS.

A list of all available test sequences will be presented, those described with a ? detail blank sequences.



The following screen image shows a test sequence in completed form configured using a HAL104. The Test comprises an Earth Bond 50Hz, AC Hipot, Insulation Resistance and Power and Leakage Test.

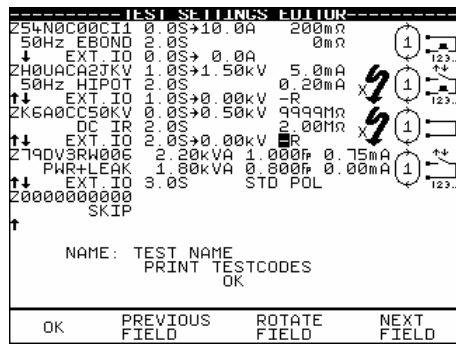

Each test will now be broken down into single components to explain the user configurable parameters

Earth Bond Test

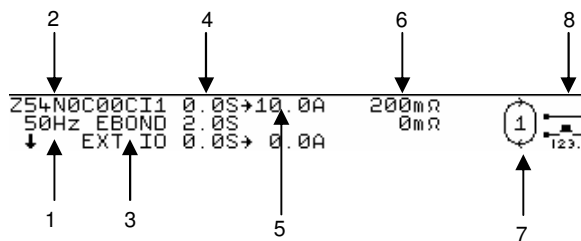

1. Test to be performed, in this example a 50Hz Earth Bond Test
2. Test Code – The test code represents the test to be performed in code format, please see the User manual for further information
3. EXT IO – External Control Port configuration. Allows the user to enable digital outputs and analogue inputs, if required.
4. Test Times – The HAL series allows for three test times, (from top to bottom respectively), Ramp Up Time, Hold (Test) Time, and Ramp Down Time.
5. Test Current – User selectable Test Current.
6. Limits Field – Allows both an Upper and Lower level of resistance to be entered to determine pass / fail levels.
7. Number of Tests – User can select the number of tests to be performed, 1 to 5 in single steps, 5 – 20 in steps of 5, or

UL for an unlimited number of repeats (i.e. as many as the user wishes to perform)

8. Start Condition – The actions that must be performed in order to start the test. In this example the Test will be initiated via the Start Button (or depress of the Earth Probe). Please refer to the manual for further start conditions, note the 123 symbol at beneath the start condition indicates that the Start action must be performed for all repeats.

Hipot Test (50Hz, 60Hz, DC)

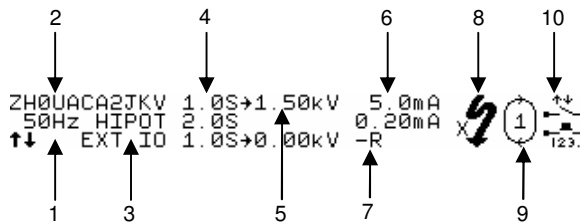

1. Test to be performed, in this example a 50Hz Hipot Test
2. Test Code – The test code represents the test to be performed in code format, please see the User manual for further information
3. EXT IO – External Control Port configuration. Allows the user to enable digital outputs and analogue inputs, if required.
4. Test Times – The HAL series allows for three test times, (from top to bottom respectively), Ramp Up Time, Hold (Test) Time, and Ramp Down Time.
5. Test Voltage – User selectable Test Voltage.
6. Limits Field – Allows both an Upper and Lower level of measured current to be entered to determine pass / fail levels.
7. Output Port – Defines where the Test Voltage is to be sent, either the Front HT Ports or the Rear Output Box. In the example above the test voltage is sent only to the Rear Output box. (Only Available in H103/104 and LED Variants)
8. Arc Detection System – Sensitivity of the system can be set between 1 and 9.
9. Number of Tests – User can select the number of tests to be performed. 1 to 5 in single steps, 5 – 20 in steps of 5, or

UL for an unlimited number of repeats (i.e. as many as the user wishes to perform)

10. Start Condition – The actions that must be performed in order to start the test. In this example the Test will be initiated via closing the Guard Switch and pressing the Green Start Button. Please refer to the manual for further start conditions

Insulation Resistance Test

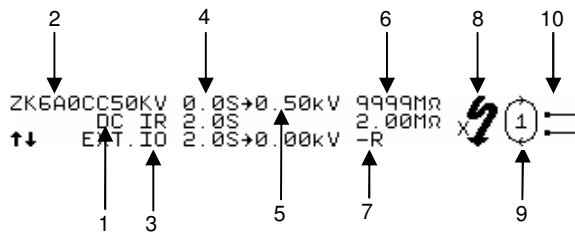

1. Test to be performed, in this example a DC Insulation Resistance Test
2. Test Code – The test code represents the test to be performed in code format, please see the User manual for further information
3. EXT IO – External Control Ports configuration, allows the user to enable digital outputs and analogue inputs, if required.
4. Test Times – The HAL series allows for three test times (from top to bottom respectively), Ramp Up Time, Hold (Test) Time, and Ramp Down Time.
5. Test Voltage – User selectable Test Voltage.
6. Limits Field – Allows both an Upper and Lower level of Resistance to be entered to determine pass / fail levels.
7. Output Port – Defines where the Test Voltage is to be sent, either the Front HT Ports or the Rear Output Box. In the example above the test voltage is sent only to the Rear Output box. (Only Available in H103/104 and LED Variants)
8. Arc Detection System – Sensitivity of the system can be set between 1 and 9.
9. Number of Tests – User can select the number of tests to be performed. 1 to 5 in single steps, 5 – 20 in steps of 5, or

UL for an unlimited number of repeats (i.e. as many as the user wishes to perform)

10. Start Condition – The actions that must be performed in order to start the test, In this example the test will begin with no user interaction. Please refer to the manual for further start conditions

Power & Leakage / Touch Leakage

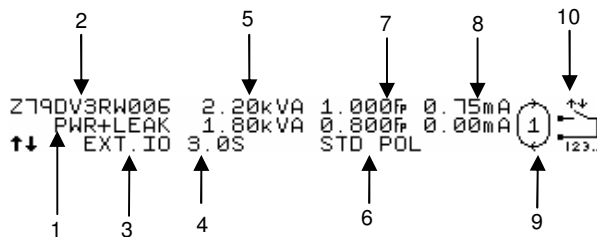

1. Test to be performed, in this example a Power and Leakage Test. Note power and Touch Leakage will be displayed as PWR+TLEAK
2. Test Code – The test code represents the test to be performed in code format, please see the User manual for further information
3. EXT IO – External Control Ports configuration, allows the user to enable digital outputs and analogue inputs, if required.
4. Test Times – The length of time the test will run for, can be set to unlimited time to be user controlled.
5. Power Measurement Test Voltage – User can select an upper and lower limit for the Power Measurement
6. Polarity Option – The user can define whether the HAL performs the load / leakage tests at Standard Polarity or Standard and Reversed, where the HAL automatically switches the live / neutral polarity and performs the load test.
7. Power Factor Measurement - User can select an upper and lower limit for the Power Factor Measurement
8. Leakage Measurement – User can select an upper and lower limit for the Earth or Touch Leakage
9. Number of Tests – User can select the number of tests to be performed, 1 to 5 in single steps, 5 – 20 in steps of 5, or UL for an unlimited number of repeats (i.e. as many as the user wishes to perform)

10. Start Condition – The actions that must be performed in order to start the test, in this example the test will begin only when the Guard Switch is closed.

9. Connection Diagrams

The below diagrams show how to connect the HAL to an item under test, for each of the available tests.

Earth Bond Testing (HAL103/104/LED Only)

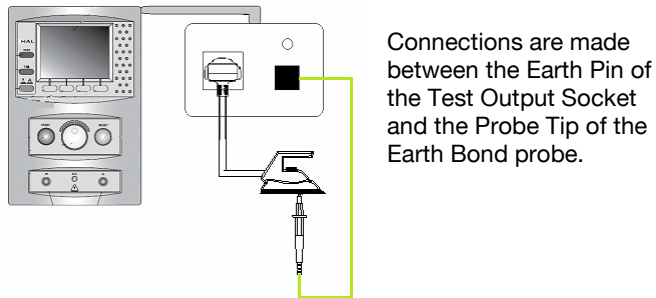

Dielectric Strength AC / DC and Insulation Resistance to Front Ports (All Models)*

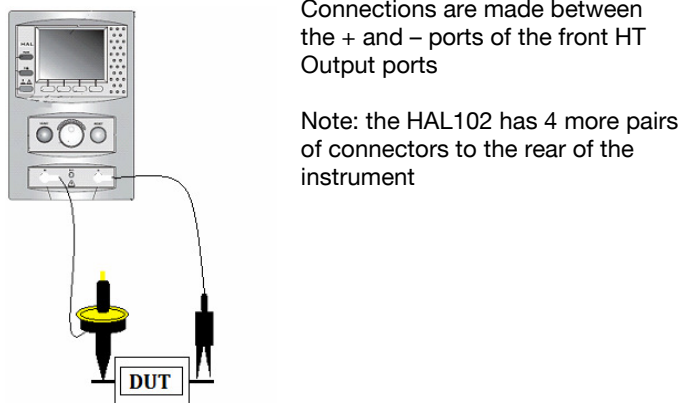

Dielectric Strength AC / DC and Insulation Resistance to Rear Ports (HAL 103/104/LED)

Earthed (Class 1) Product

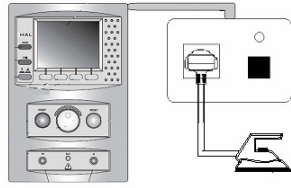

Connections made between L&N tied together and the Earth conductor in Test Output Socket

Double Insulated (Class 2) Product

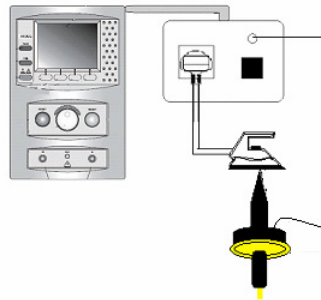

Connections made between L&N Tied together and the HT Probe or Clip

Power and Leakage Measurement (HAL104/LED Only)

Voltage Selection Switch

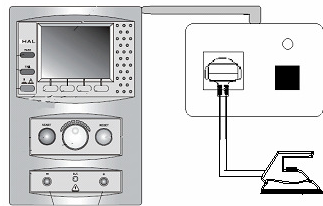

If using the HAL to supply mains voltage for the test ensure the Rocker Switch is placed into the NORMAL position.

If using an external supply, ensure the Rocker Switch on the rear of the unit is placed in the AUX Position.

Connections made between Live, Neutral and Earth Conductors in the Test Output Socket

Power and Touch Leakage Measurement (HAL104/LED Only)

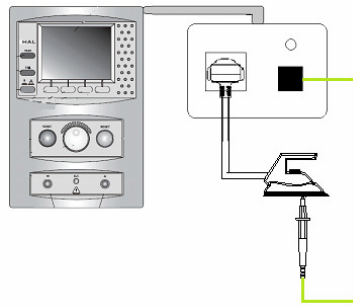

Voltage Selection Switch

If using the HAL to supply mains voltage for the test ensure the Rocker Switch is placed into the NORMAL position.

If using an external supply, ensure the Rocker Switch on the rear of the HAL is placed in the AUX Position

Connections made between Live, Neutral Conductors in the Test Output Socket and the Earth Bond Probe.

10. The Test Screen

The below is an example of a test screen, in this example a 50Hz Hipot Test. The test screen is divided into 3 main sections as shown below;

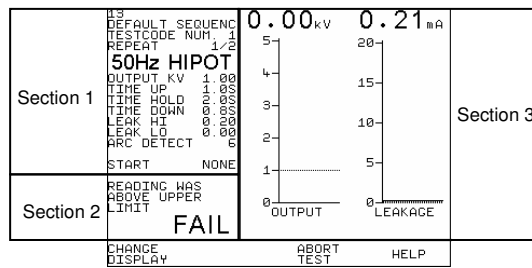

Section 1, Test Information - This section displays general information about the test, including Test Parameters, Test Sequence, Test Type, Asset Number, Test Repeats and Start Condition.

Section 2, Test Status – This section displays the current status of the test in progress, including a display of the test time whilst in progress.

Section 3, Test Output – This section displays information relating to the test being performed. The section can be displayed as a bar graph including Pass Limits and Output targets (Voltage or Current) or as a simple numeric display.

11. Reviewing the Memory

The Onboard memory of the HAL can be reviewed via the graphics display. The data displayed can be subjected to a search function so that only the results of interest are displayed.

In order to review the data via the HAL from the MAIN MENU scroll to VIEW TEST RESULTS and press the green Start button.

```
-----SEARCH FOR DATA-----
PRODUCT: *
SITE: *
LOCATION: *
USER: *
TEST STATUS: *
STORAGE STATUS: NORMAL
DATE FROM: 01/01/1900 00:00
DATE TO: 12/11/2014 13:43
START SEARCH
```

The above screen will be displayed, giving the user the option to narrow down the displayed results. The outcome of each option is shown below

PRODUCT – Useful if looking for a particular item, this field will search the Product ID Field.

SITE – Results can be narrowed down by a particular site (if used)

LOCATION – Results can be narrowed down by a location (if used)

USER – Allows results to be narrowed down by a particular user.

TEST STATUS – Allows either only PASSED or FAILED items to be displayed

STORAGE STATUS – user can choose between NORMAL (all results stored in the Normal memory), DELETED (any result in a Deleted state, not results that have been deleted using the CLEAR RESULTS option) and * (shows results for both NORMAL and DELETED fields)

DATE FROM / DATE TO – Allows for a particular date and time range to be applied to the test results search function

Once complete, scroll to START SEARCH and press the Start key, or press function key 4, to begin the search and display the requested results.

12. Downloading Results

The HAL can output data in a number of formats and to a number of software packages (including Safety E-Base and PATGuard), please refer to the individual software instructions for full guidance on compatibility and configuring the software to receive the output. Ensure the supplied Download cable is used and connected to the Top RS-232 port on the rear of the HAL.

To Download the HAL, from the MAIN MENU, select DOWNLOAD RESULTS, and the following screen will be displayed

```
-----DOWNLOAD OPTIONS-----
DESTINATION: PC
OUTPUT CONNECTION: RS232
BAUD RATE: 19200
DOWNLOAD FORMAT: SSS
OK
```

```
-----SEARCH FOR DOWNLOAD DATA-----
PRODUCT: *
SITE: *
LOCATION: *
USER: *
TEST STATUS: *
STORAGE STATUS: NORMAL
DATE FROM: 01/01/1900 00:00
DATE TO: 12/11/2014 13:57
START SEARCH
```

Configure the options as required, then scroll to START SEARCH to begin the download, and a progress bar will be

displayed indicating the number of tests being downloaded from the total memory. Please note downloading the memory does not delete the results from memory.

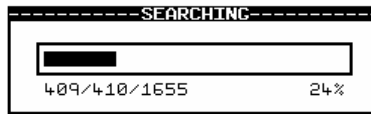

13. Print Labels using the Desk Test n Tag Printer

In addition to downloading results to a PC the HAL can output status labels after a test. The below describes the configuration required to output the labels, please refer to the Desk Test n Tag manual for instructions on configuring the printer.

From the MAIN MENU, scroll to SETUP, then SYSTEM CONFIGURATION. Using the wheel scroll to AFTER TEST and select either option that begins with DOWNLOAD, as shown below;

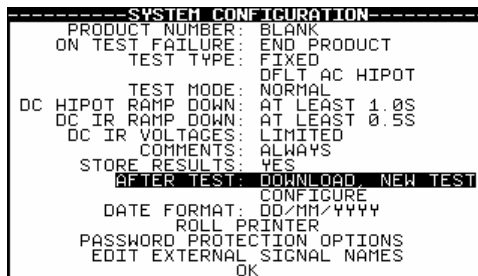

Once DOWNLOAD has been selected, the option to CONFIGURE will become active. Scroll to this and press the Green button to enter the configure menu. Ensure the options are configured as shown below, then confirm by scrolling the OK option and pressing the Green Button to confirm.

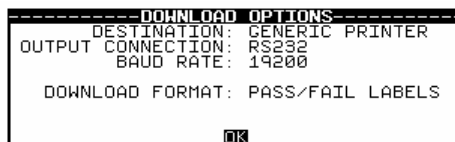

Rev 1.1